



**Business Results for Nine Months  
(April-December, 2021) of FY2021  
【Telephone conference】**

**Komatsu Ltd. Participants**

**Takeshi Horikoshi  
Masatoshi Morishita**

**Director and Senior Executive Officer and CFO  
Senior Executive Officer and  
GM, Business Coordination Department**

**January 31, 2022**

## I . Business Results for Nine Months ended December 31, 2021 <PP3-13>

- PP4-6 : Highlights, Segment Sales and Profits for the Third Quarter (Oct.- Dec., 2021)
- PP7-8 : Highlights, Segment Sales and Profits for Nine Months (Apr.-Dec., 2021)
- PP9-10 : Construction, Mining & Utility Equipment: Results for Nine Months (Apr.-Dec., 2021)
- P11 : Retail Finance: Assets and Revenues for Nine Months (Apr.-Dec., 2021)
- P12 : Industrial Machinery & Others: Results for Nine Months (Apr.-Dec., 2021)
- P13 : Consolidated Balance Sheets

## II . Outlook of FY2021 Business Results <PP14-24>

- PP15 : Projection for FY2021 ending March 31, 2022: Outline and Segment Sales and Profit
- PP16-21 : Construction, Mining & Utility Equipment: Demand and Outlook for Seven Major Products (Global and By Region)
- PP22-23 : Construction, Mining & Utility Equipment: Mining Equipment
- P24 : Construction, Mining & Utility Equipment: Parts

## Appendix <PP25-34>

- P26 : Daily Komtrax data
- PP27-31 : Quarterly Results
- PP32-34 : Book-to-Bill Ratio [Orders Received / Sales (6 Months)]

# **I . Business Results for Nine Months ended December 31, 2021**

# Highlights of Business Results for the Third Quarter (Oct.-Dec.,2021)

- Consolidated net sales increased by 30.2% from the corresponding period a year ago, to JPY723.2 billion.
- Operating income advanced by 85.4% to JPY87.4 billion. Operating income ratio was 12.1%, up 3.6 points.
- Net income attributable to Komatsu Ltd. surged by 117.4% to JPY62.3 billion.

Billions of yen	Oct.-Dec.,2020 (A) ¥104.9/USD ¥123.4/EUR ¥15.7/RMB	Oct.-Dec.,2021 (B) ¥112.9/USD ¥129.7/EUR ¥17.6/RMB	Changes (B-A)	
			Increase (Decrease)	Change %
Net sales	555.5	723.2	+167.6	+30.2%
Segment profit	47.4	85.7	+38.2	+80.7%
Other operating income (Expenses)	(0.2)	1.7	+2.0	-
Operating income	47.1	87.4	+40.2	+85.4%
Profit ratio	8.5%	12.1%	+3.6pts	-
Other income (Expenses)	(2.3)	0.3	+2.6	-
Income before income taxes	44.8	87.8	+42.9	+95.9%
Net income attributable to Komatsu Ltd.	28.6	62.3	+33.6	+117.4%

# Segment Sales and Profits for the Third Quarter (Oct.- Dec., 2021)

- **Construction, Mining & Utility Equipment:** Sales advanced by 30.7% from the corresponding period a year ago, to JPY660.1 billion. Segment profit expanded by 94.2% to JPY73.2 billion. Segment profit ratio improved to 11.1%, up 3.6 points.
- **Retail Finance:** Revenues increased by 5.0% from the corresponding period a year ago, to JPY17.6 billion. Segment profit advanced sharply by 55.7% to JPY5.4 billion.
- **Industrial Machinery & Others:** Sales advanced by 35.4% from the corresponding period a year ago, to JPY50.1 billion. Segment profit advanced by 32.7% to JPY6.4 billion.

Billions of yen	Oct.-Dec., 2020 (A)	Oct.-Dec., 2021 (B)	Changes (B-A)	
			Increase (Decrease)	Change %
<b>Net sales</b>	555.5	723.2	+167.6	+30.2%
Construction, mining & utility equipment	505.2 [504.0]	660.1 [659.0]	+154.9 [+154.9]	+30.7% [+30.7%]
Retail finance	16.7 [14.7]	17.6 [14.6]	+0.8 [(0.1)]	+5.0% [(0.7)%]
Industrial machinery & others	37.0 [36.7]	50.1 [49.5]	+13.1 [+12.8]	+35.4% [+35.0%]
Elimination	(3.4)	(4.6)	(1.2)	-
<b>Segment profit</b>	8.5% 47.4	11.9% 85.7	+3.4pts. +38.2	+80.7%
Construction, mining & utility equipment	7.5% 37.7	11.1% 73.2	+3.6pts. +35.5	+94.2%
Retail finance	20.8% 3.4	30.9% 5.4	+10.1pts. +1.9	+55.7%
Industrial machinery & others	13.2% 4.8	12.9% 6.4	(0.3)pts. +1.5	+32.7%
Corporate & elimination	1.3	0.5	(0.7)	-

## Review of three business segments:

☐ % : Profit ratio [ ] : Sales after elimination of inter-segment transactions

- **Construction, Mining & Utility Equipment:** Sales advanced, mainly supported by increased volume of sales, positive effects of foreign exchange rates and improved selling prices. Segment profit climbed, mainly supported by increased volume of sales.
- **Retail Finance:** Revenues increased supported by an increase in new contracts resulting from expanded sales of the construction, mining & utility equipment business. Segment profit advanced mainly due to improved residual value and resale profits of leased equipment against the backdrop of buoyant market conditions as well as decreased allowance for doubtful receivables.
- **Industrial Machinery & Others:** Concerning presses and machine tools for the automobile manufacturing industry, both sales and profits advanced reflecting mainly an increase in sales of machine tools for China. With respect to products for the semiconductor manufacturing industry, both sales and profits increased, esp. supported by excellent sales of the Excimer laser-related business.

# Construction, Mining & Utility Equipment : Sales by Region (To Outside Customers) for the Third Quarter (Oct.-Dec.,2021)

- Sales to outside customers advanced by 30.7% from the corresponding period a year ago, to JPY659.0 billion.
- Sales improved in all regions, except for China. Sales expanded sharply in Asia, North America, Latin America, and CIS.
- The ratio of sales in Strategic Markets increased to 54% of total sales.

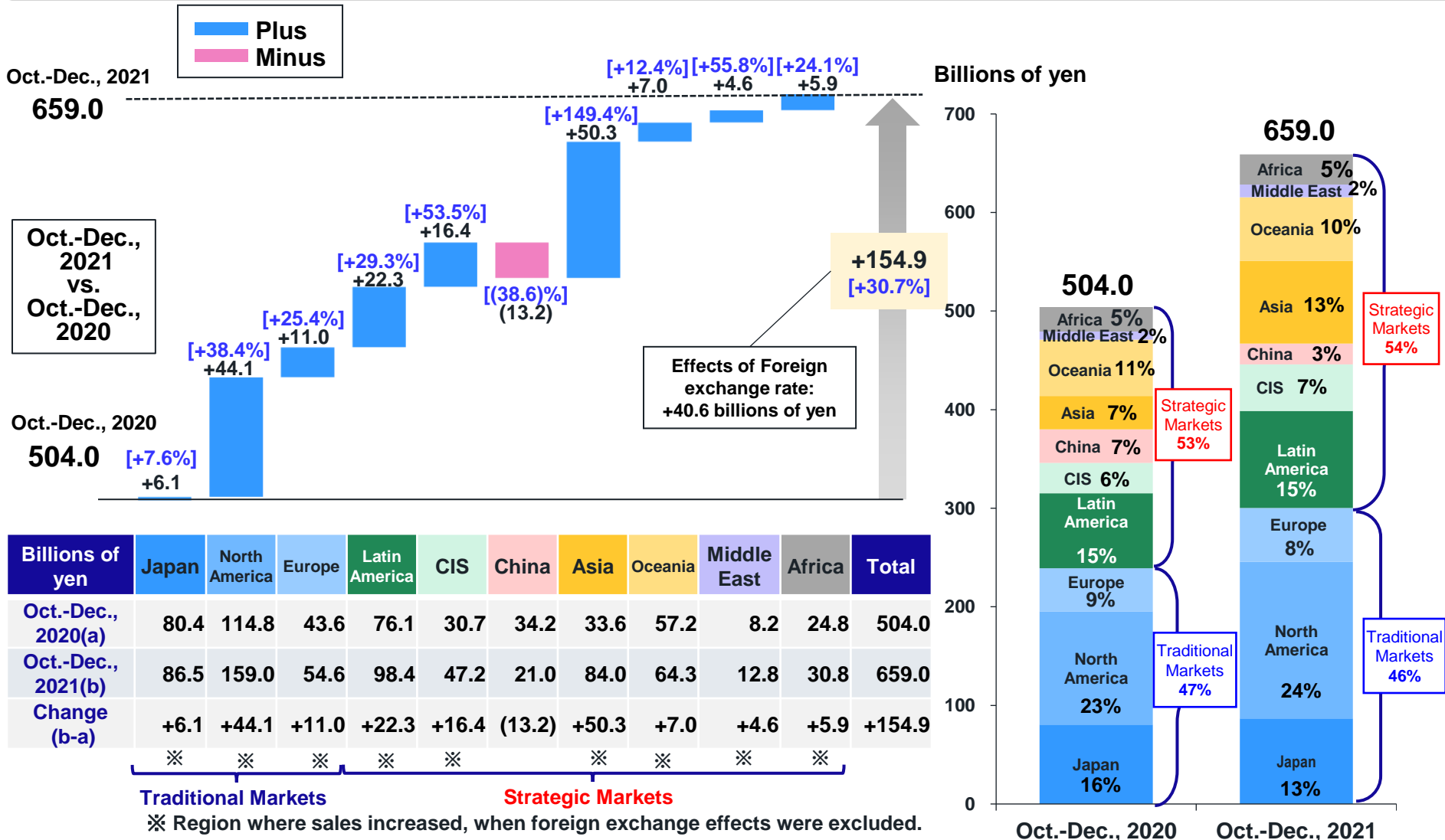

# Highlights of Business Results for Nine Months (Apr.-Dec., 2021)

- Consolidated net sales advanced by 33.1% from the corresponding period a year ago, to JPY2,014.6 billion.
- Operating income expanded sharply by 108.1% to JPY223.7 billion. Operating income ratio was 11.1%, up 4.0 points.
- Net income attributable to Komatsu Ltd. surged by 135.7% to JPY155.5 billion.

Billions of yen	Apr.-Dec.,2020 (A) ¥106.4/USD ¥122.1/EUR ¥/15.4RMB	Apr.-Dec.,2021 (B) ¥111.0/USD ¥130.6/EUR ¥17.2/RMB	Changes (B-A)	
			Increase (Decrease)	Change %
Net sales	1,513.3	2,014.6	+501.3	+33.1%
Segment profit	108.2	220.5	+112.3	+103.8%
Other operating income (Expenses)	(0.6)	3.2	+3.8	-
Operating income	107.5	223.7	+116.2	+108.1%
Profit ratio	7.1%	11.1%	+4.0pts	-
Other income (Expenses)	(4.1)	0.5	+4.7	-
Income before income taxes	103.3	224.3	+120.9	+117.0%
Net income attributable to Komatsu Ltd.	65.9	155.5	+89.5	+135.7%

# Segment Sales and Profits for Nine Months (Apr.-Dec., 2021)

- Construction, Mining & Utility Equipment: Sales advanced by 33.6% from the corresponding period a year ago, to JPY1,845.5 billion. Segment profit expanded sharply advanced by 113.3% to JPY191.8 billion. Segment profit ratio improved to 10.4%, up 3.9 points.
- Retail Finance: Revenues increased by 10.2% from the corresponding period a year ago, to JPY54.5 billion. Segment profit expanded by 62.5% to JPY13.2 billion.
- Industrial Machinery & Others: Sales increased by 29.3% from the corresponding period a year ago, to JPY131.8 billion. Segment profit advanced sharply by 67.8% to JPY15.0 billion.

Billions of yen	Apr.-Dec., 2020 (A)	Apr.-Dec., 2021 (B)	Changes (B-A)	
			Increase (Decrease)	Change %
<b>Net sales</b>	1,513.3	2,014.6	+501.3	+33.1%
Construction, mining & utility equipment	1,381.7 [1,368.4]	1,845.5 [1,840.6]	+463.7 [+472.2]	+33.6% [+34.5%]
Retail finance	49.5 [43.6]	54.5 [43.5]	+5.0 [(0.1)]	+10.2% [(0.3)%]
Industrial machinery & others	102.0 [101.2]	131.8 [130.4]	+29.8 [+29.2]	+29.3% [+28.9%]
Elimination	(19.9)	(17.2)	+2.6	-
<b>Segment profit</b>	<span>7.2%</span> 108.2	<span>10.9%</span> 220.5	<span>+3.7pts.</span> +112.3	+103.8%
Construction, mining & utility equipment	<span>6.5%</span> 89.9	<span>10.4%</span> 191.8	<span>+3.9pts.</span> +101.9	+113.3%
Retail finance	<span>16.5%</span> 8.1	<span>24.3%</span> 13.2	<span>+7.8pts.</span> +5.1	+62.5%
Industrial machinery & others	<span>8.8%</span> 8.9	<span>11.4%</span> 15.0	<span>+2.6pts.</span> +6.0	+67.8%
Corporate & elimination	1.0	0.3	(0.7)	-

## Review of three business segments:

  % : Profit ratio [ ] : Sales after elimination of inter-segment transactions

- **Construction, Mining & Utility Equipment:** Sales advanced, mainly supported by increased volume of sales, positive effects of foreign exchange rates and improved selling prices. Segment profit climbed, mainly supported by increased volume of sales.
- **Retail Finance:** Revenues increased, supported by an increase in new contracts resulting from expanded sales of the construction, mining & utility equipment business. Segment profit climbed mainly due to improved residual value and resale profits of leased equipment against the backdrop of buoyant market conditions as well as decreased allowance for doubtful receivables.
- **Industrial Machinery & Others:** Concerning presses and machine tools for the automobile manufacturing industry, both sales and profits advanced, reflecting the completion of installing machinery at overseas customers' plants. With respect to products for the semiconductor manufacturing industry, both sales and profits increased, esp. supported by excellent sales of the Excimer laser-related business.



# Construction, Mining & Utility Equipment : Sales by Region (To Outside Customers) for Nine Months (Apr.-Dec., 2021)

- Sales to outside customers advanced by 34.5% from the corresponding period a year ago, to JPY1,840.6 billion.
- Sales improved in all regions, except for China. Sales expanded sharply in Asia, North America, Latin America, and CIS.
- The ratio of sales in Strategic Markets increased to 56% of total sales.

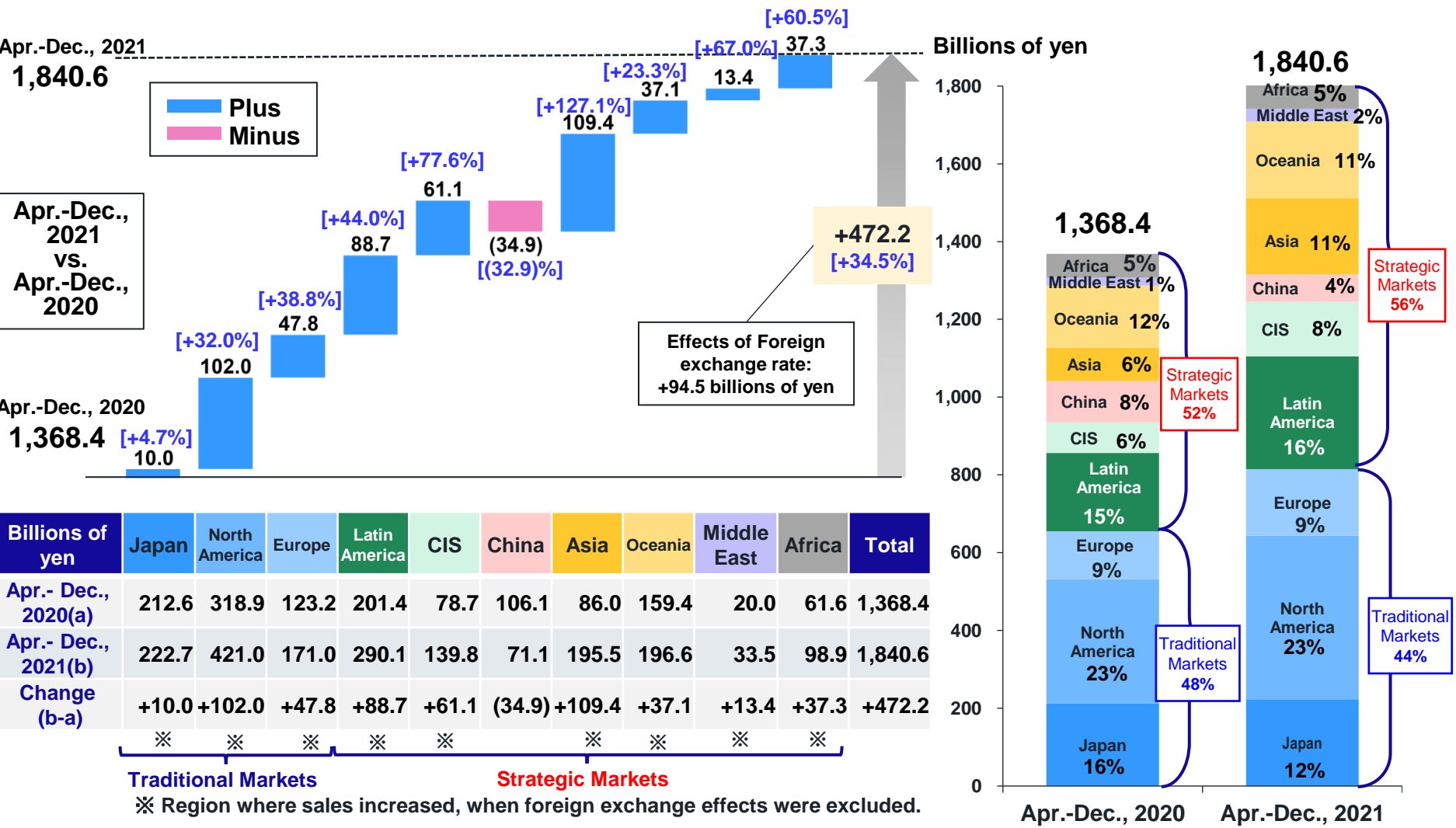

# Construction, Mining & Utility Equipment : Causes of Difference in Sales and Segment Profit for Nine Months (Apr.-Dec., 2021)

- Sales increased by JPY463.7 billion from the corresponding period a year ago, mainly supported by increased volume of sales, positive effects of foreign exchange rates and improved selling prices.
- Segment profit increased by JPY101.9 billion from the corresponding period a year ago, reflecting increased volume of sales.
- Segment profit ratio was 10.4%, up 3.9 points from the corresponding period a year ago.

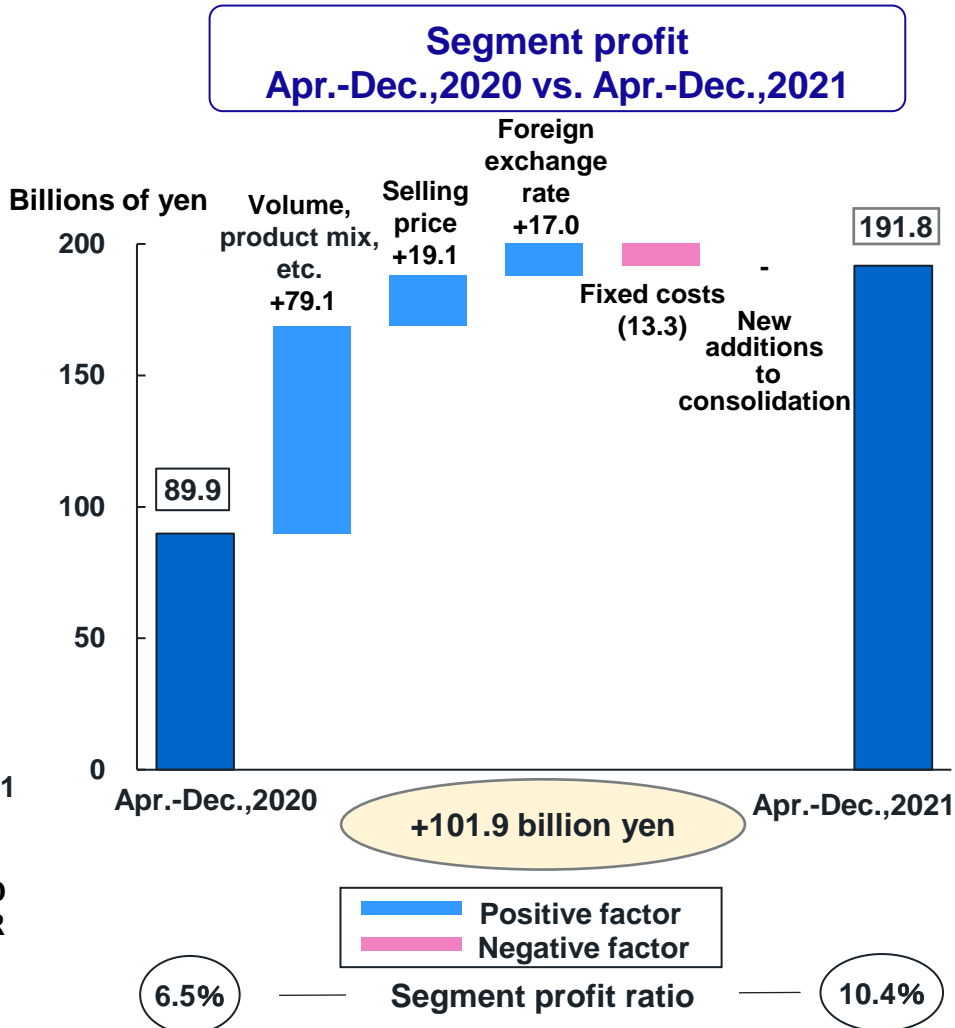
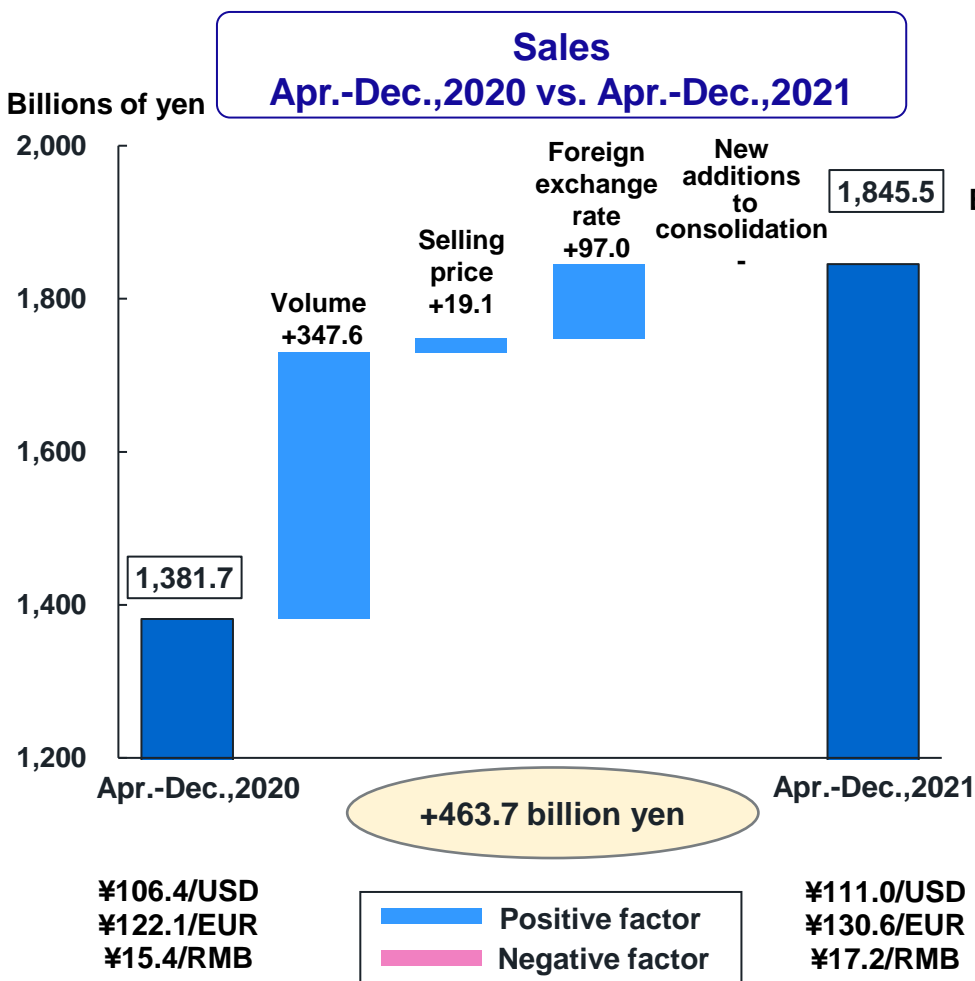

# Retail Finance: Assets and Revenues for Nine Months (Apr.-Dec., 2021)

- Assets increased from the previous fiscal year-end, as mainly affected by an increase in new contracts and foreign exchange rates.
- New contracts increased by JPY109.4 billion from the corresponding period a year ago, supported by increased sales of the construction, mining and utility equipment business.
- Revenues increased by JPY5.0 billion, supported by an increase in new contracts.
- Segment profit advanced by JPY5.1 billion from the corresponding period a year ago, mainly due to improved residual value and resale profits of leased equipment against the backdrop of buoyant market conditions as well as decreased allowance for doubtful receivables.

Billions of yen  
1,000

**Assets**  
Mar.31, 2021 vs. Dec.31, 2021

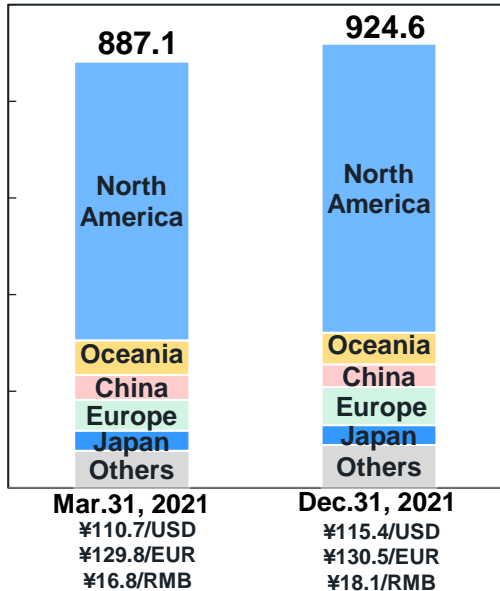

Billions of yen  
600

**New Contracts**  
Apr.-Dec.,2020 vs. Apr.-Dec.,2021

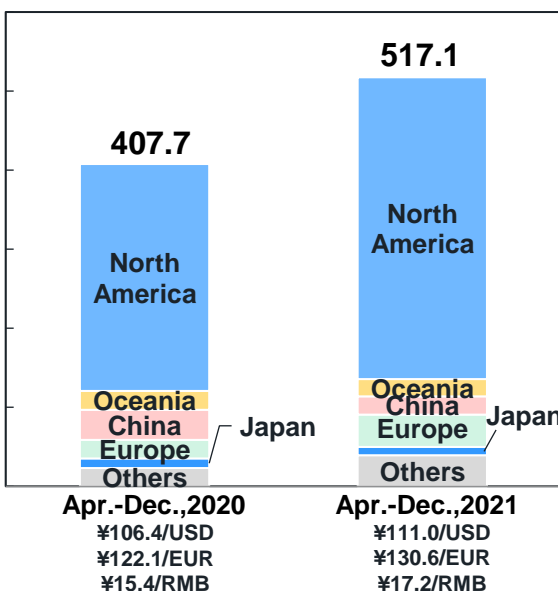

Billions of yen

**Revenues**  
Apr.-Dec.,2020 vs. Apr.-Dec.,2021

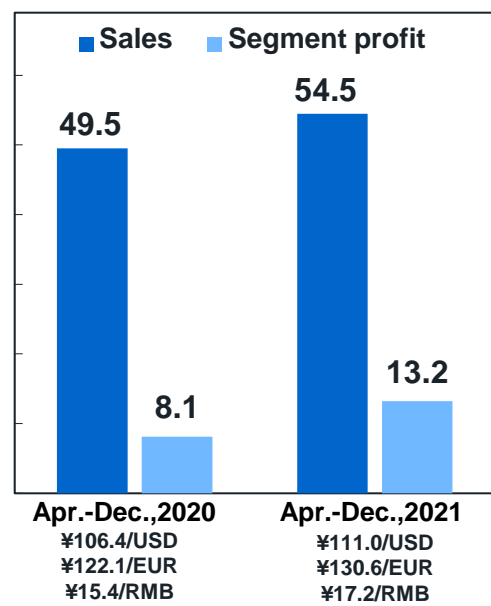

Billions of yen	2021/3E	2021/12E	Changes
Interest-bearing debt	674.7	699.2	+24.5
Interest-bearing debt, net	672.3	693.4	+21.1
Net D/E ratio	3.69	3.49	(0.2)pts.

# Industrial Machinery & Others: Sales and Segment Profit for Nine Months (Apr.-Dec., 2021)

- Sales increased by 29.3% from the corresponding period a year ago, to JPY131.8 billion.
- Segment profit expanded by 67.8% to JPY15.0 billion.
- Presses and machine tools for the automobile manufacturing industry: Both sales and segment increased.
- Products for the semiconductor manufacturing industry: Both sales and profits increased, esp. supported by excellent sales of the Excimer laser-related business.
- Segment profit ratio was 11.4%.

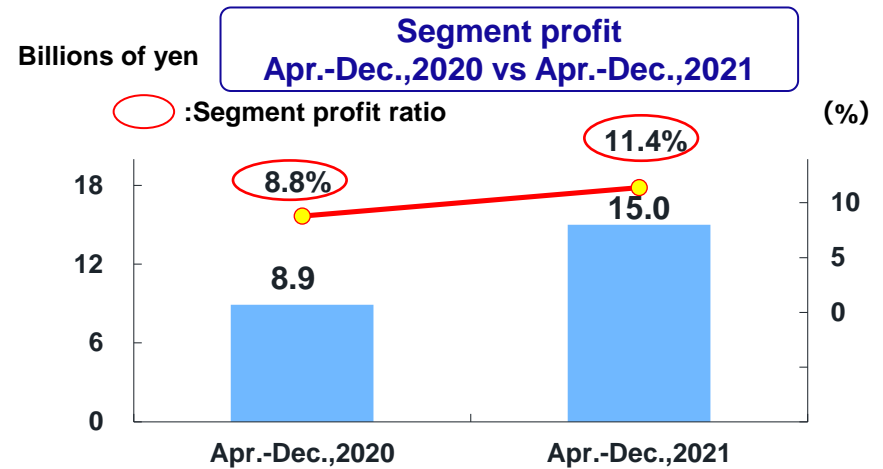
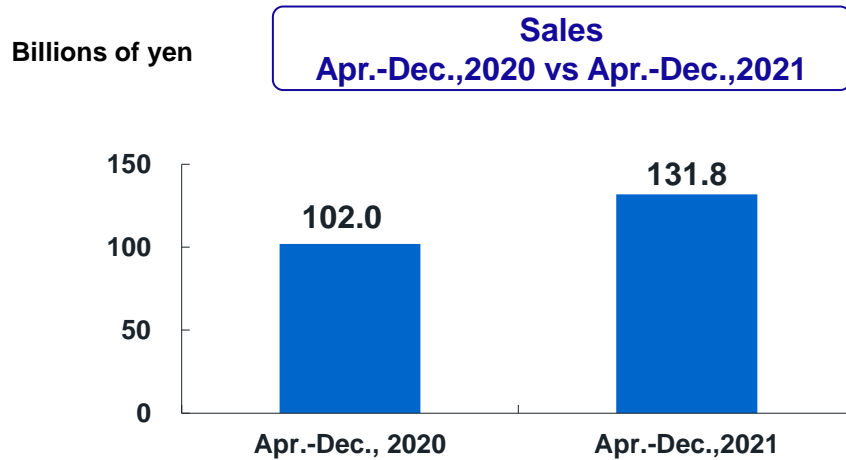

## Breakdown of sales

Billions of yen	Apr.-Dec., 2020	Apr.-Dec., 2021	Changes	
			Increase (Decrease)	Change %
Komatsu Industries Corp.	28.7	37.7	9.0	+31.3%
Komatsu NTC Ltd.	20.5	26.9	6.3	+30.9%
Gigaphoton Inc.	29.3	39.3	9.9	+34.0%
Others	23.3	27.8	4.5	+19.3%
<b>Total</b>	<b>102.0</b>	<b>131.8</b>	<b>29.8</b>	<b>+29.3%</b>

# Consolidated Balance Sheets

- Total assets increased by JPY242.5 billion from the previous fiscal year-end, to JPY4,027.3 billion.
- Inventories increased resulting from an increase of demand in the construction, mining and utility equipment business.
- Komatsu Ltd. shareholders' equity ratio increased by 0.7 percentage points, to 51.2%.

Billions of yen : Net D/E ratio	Mar. 31, 2021 ¥110.7/USD ¥129.8/EUR ¥16.8/RMB	Dec. 31, 2021 ¥115.4/USD ¥130.5/EUR ¥18.1/RMB	Increase (Decrease)
Cash & deposits (incl. time deposits) [a]	243.1	273.3	+30.1
Accounts receivable (incl. long-term trade receivables)	1,267.5	1,332.3	+64.7
Inventories	793.8	901.3	+107.4
Tangible fixed assets	787.3	792.2	+4.8
Other assets	692.9	728.1	+35.2
<b>Total assets</b>	<b>3,784.8</b>	<b>4,027.3</b>	<b>+242.5</b>
Accounts payable	258.3	286.9	+28.6
Interest-bearing debt [b]	909.9	923.9	+13.9
Other liabilities	604.5	629.9	+25.4
<b>Total liabilities</b>	<b>1,772.8</b>	<b>1,840.8</b>	<b>+68.0</b>
[Shareholders' equity ratio]	[50.5%]	[51.2%]	[0.7%]
Komatsu Ltd. shareholders' equity	1,912.2	2,063.7	+151.4
Non-controlling interests	99.7	122.7	+22.9
<b>Liabilities &amp; Equity</b>	<b>3,784.8</b>	<b>4,027.3</b>	<b>+242.5</b>
<b>Interest-bearing debt, net [b-a]</b>	<b>(0.35)</b> 666.8	<b>(0.32)</b> 650.6	<b>(16.2)</b>
<b>Net D/E ratio (excl. the retail finance business)</b>	<b>(0.00)</b>	<b>(0.02)</b>	

## **II . Outlook of FY2021 Business Results**

# Outline of Projection for FY2021

• We have not changed our projection of full-year results for FY2021. (See below for the projection of October 2021.)

Billions of yen	FY2020 Results (A) ¥106.0/USD ¥123.4/EUR ¥15.6/RMB	FY2021 Projection (B) (Oct.) ¥108.5/USD ¥128.6/EUR ¥16.8/RMB	FY2021 Projection (Apr.) ¥105.0/USD ¥124.0/EUR ¥16.0/RMB	Changes (B-A)	
				Increase (Decrease)	Change %
Net sales	2,189.5	2,683.0	2,469.0	+493.4	+22.5%
Segment profit	172.3	282.0	225.0	+109.6	+63.6%
Other operating income (Expenses)	(5.0)	0.0	0.0	+5.0	-
Operating income	167.3	282.0	225.0	+114.6	+68.5%
Profit ratio	7.6%	10.5%	9.1%	+2.9pts.	-
Other income (Expenses)	(4.5)	(5.0)	(8.0)	(0.4)	-
Income before income taxes	162.7	277.0	217.0	+114.2	+70.2%
Net income attributable to Komatsu Ltd.	106.2	187.0	146.0	+80.7	+76.0%
ROE	5.8%	9.6%	7.6%	+3.8pts.	
Cash dividends per share ※	55Yen	80Yen	62Yen	+25Yen	
Consolidated payout ratio	48.9%	40.4%	40.1%		

※ Annual dividends per share for FY2020 include JPY 10 for the 100th anniversary commemorative dividend.

# Construction, Mining & Utility Equipment: Actual and Projected Demand for 7 Major Products

- In 3Q FY2021, global demand remained about flat from the corresponding period a year ago. When China is excluded, demand increased by 17% from the corresponding period a year ago.
- We project that full-year demand will increase between +/-0% and 5% in FY2021 from FY2020 (Unchanged from our projection of April 2021).
- When China is excluded, we have revised demand should increase between 20% and 25% by incorporating the latest market conditions in the projection of October.

## Annual demand for 7 major products

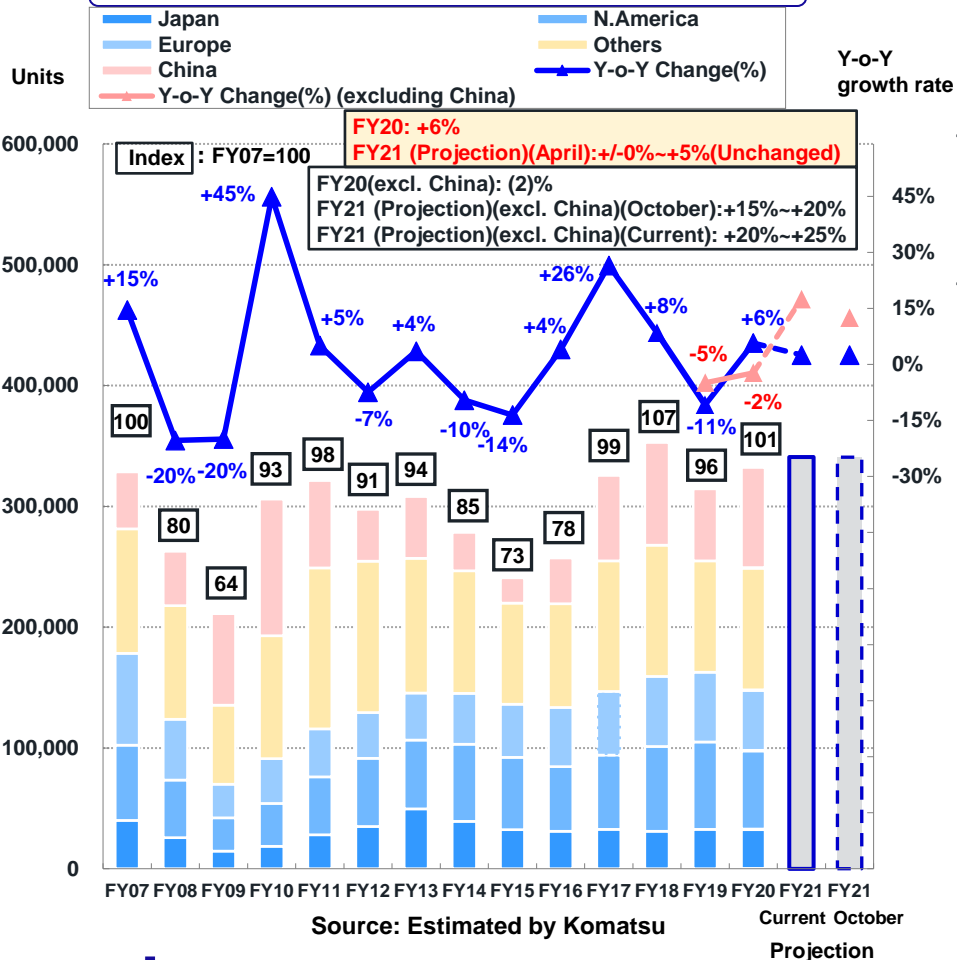

## Quarterly demand for 7 major products

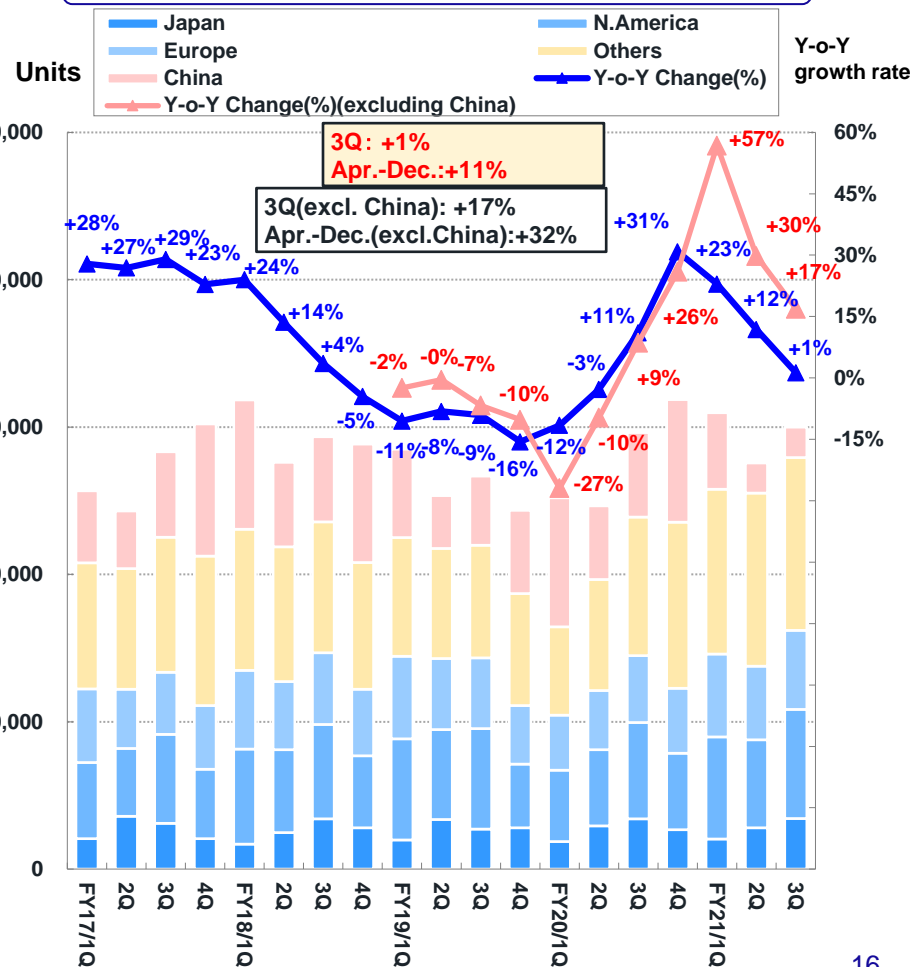



# Construction, Mining & Utility Equipment : Demand in Major Markets (1) Japan

- In 3Q FY2021, demand remained about flat from the corresponding period a year ago.
- Demand remained firm, supported by not only steady public works but also private-sector construction.
- In FY2021, demand will increase between +/-0% and 5% from FY2020 (Unchanged from our projection of April 2021).

## Demand for new equipment (7 major products) and construction investment

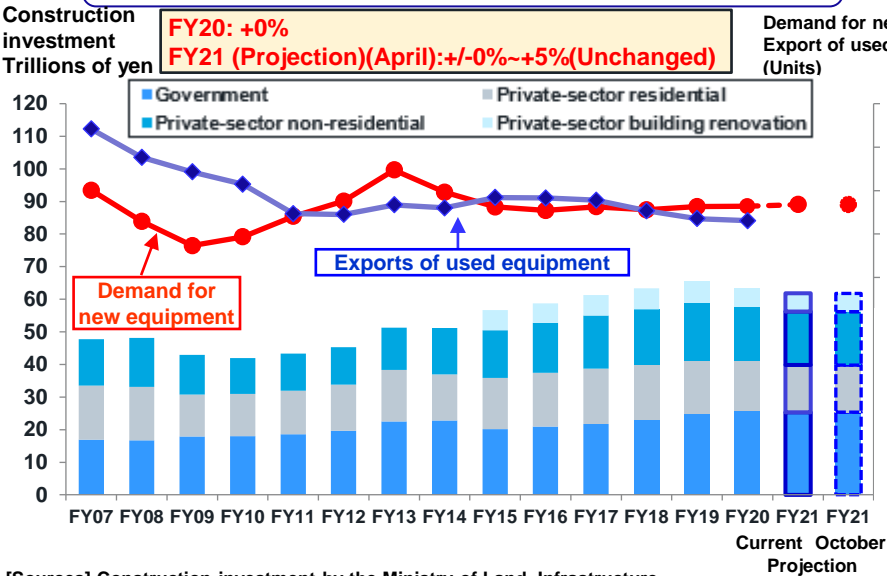

[Sources] Construction investment by the Ministry of Land, Infrastructure, Transport & Tourism, and Research Institute of Construction and Economy  
Demand for 7 major products and No. of exported used equipment estimated by Komatsu

## Komtrax in Japan: Average operating hours per month

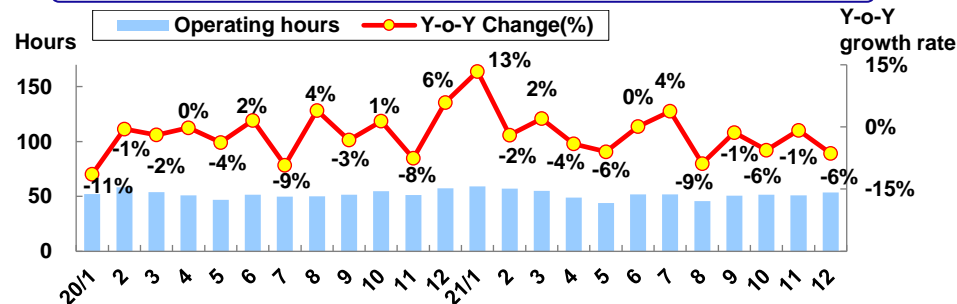

## Quarterly demand for 7 major products

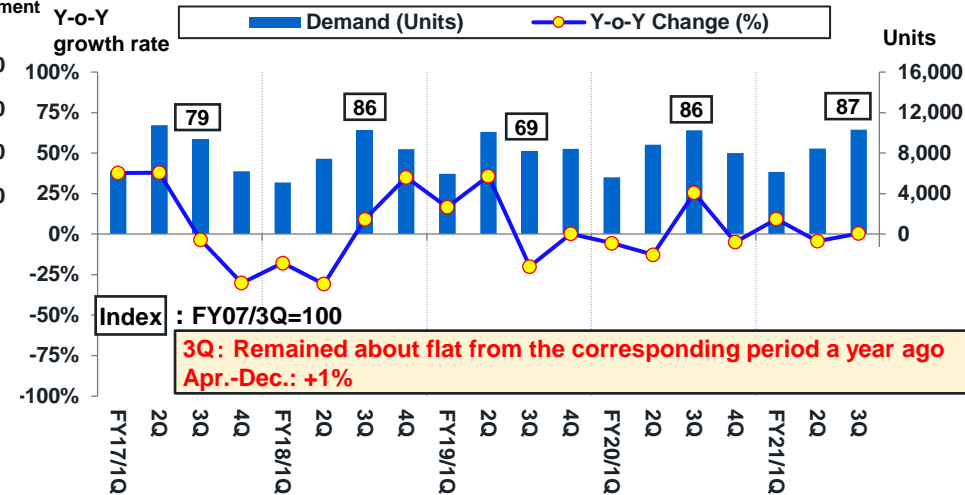

## Quarterly demand for hydraulic excavators (Rental & Regular uses)

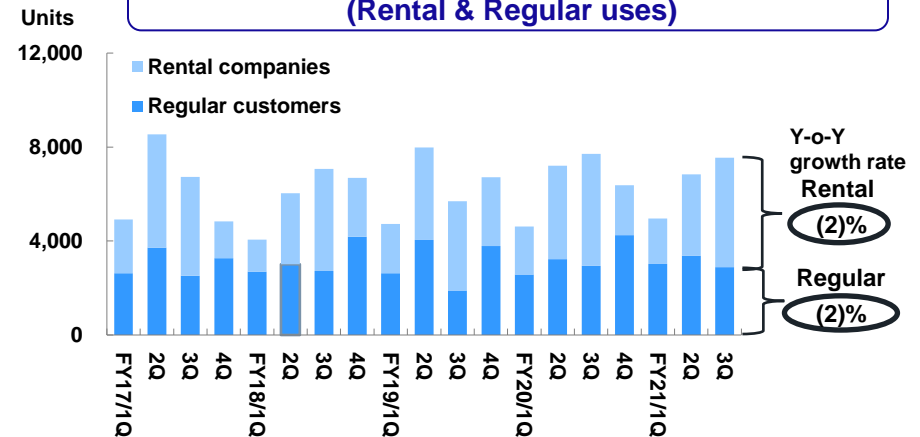

# Construction, Mining & Utility Equipment : Demand in Major Markets (2) North America

- In 3Q FY2021, demand increased by 13% from the corresponding period a year ago.
- Demand remained steady in residential and non-residential construction as well as road and traffic infrastructure. Demand for rental equipment should continue to recover.
- We project that full-year demand will increase by +15% to +20% in FY2021 from FY2020 (Unchanged from our projection of October 2021).

## Demand for 7 major products and US housing starts

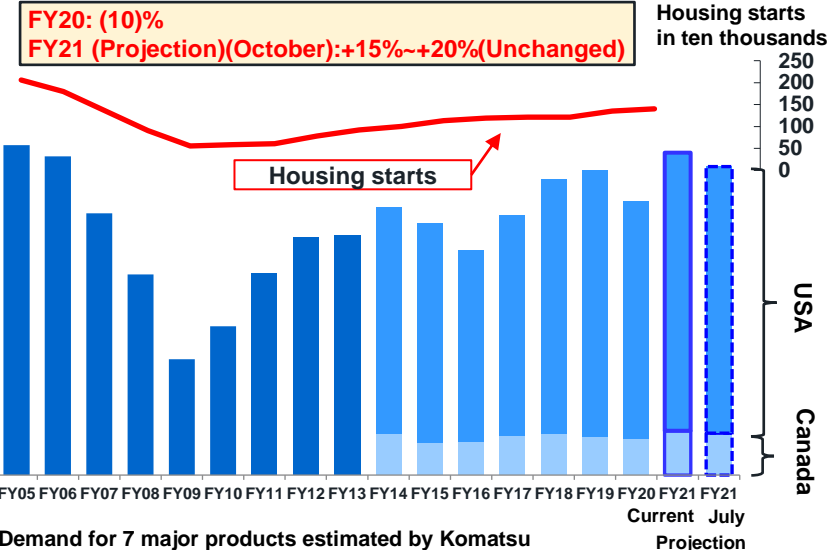

## Quarterly demand for 7 major products

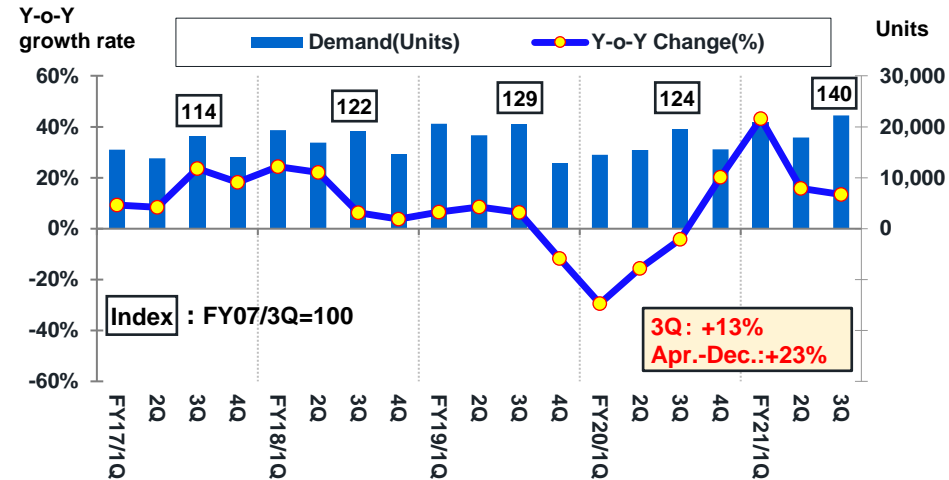

## Breakdown of demand by segment (Unit basis)

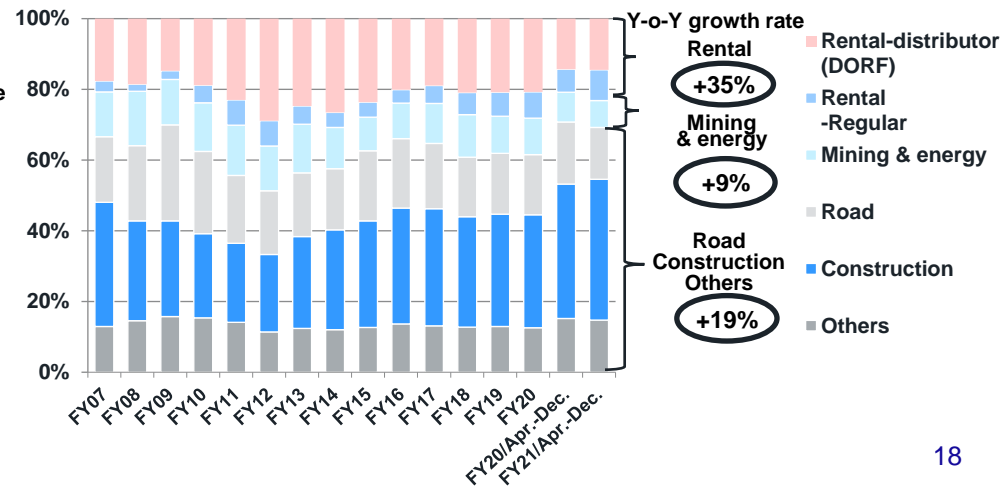

## Komtrax in North America: Average operating hours per month

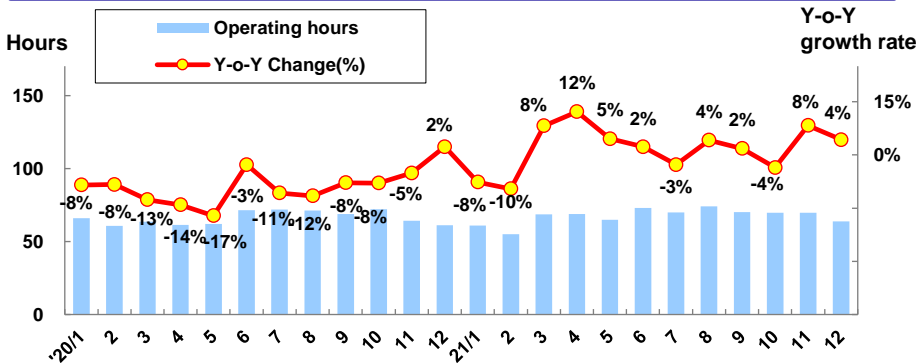

# Construction, Mining & Utility Equipment : Demand in Major Markets (3) Europe

- In 3Q FY2021, demand increased by 18% from the corresponding period a year ago.
- Demand increased, centering on the United Kingdom, France, Germany and Italy, mainly supported by economic recovery plans.
- We project that full-year demand will increase by +25% to +30% in FY2021 from FY2020 (Unchanged from our projection of October 2021).

Annual demand for 7 major products

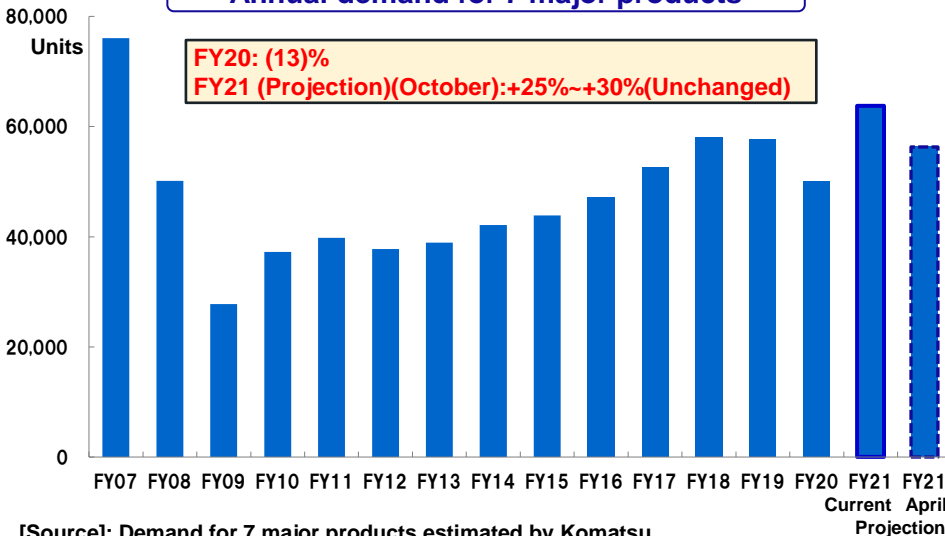

Quarterly demand for 7 major products

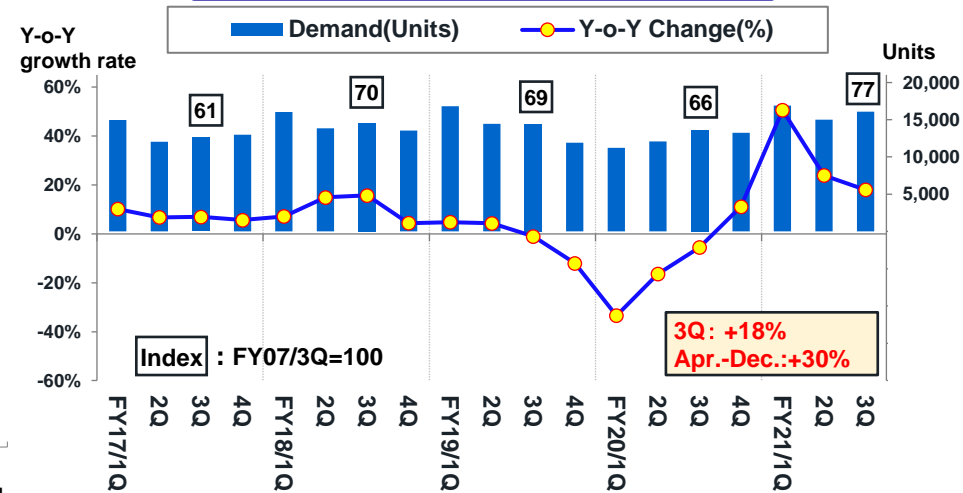

[Source]: Demand for 7 major products estimated by Komatsu

Komtrax in Europe: Average operating hours per month

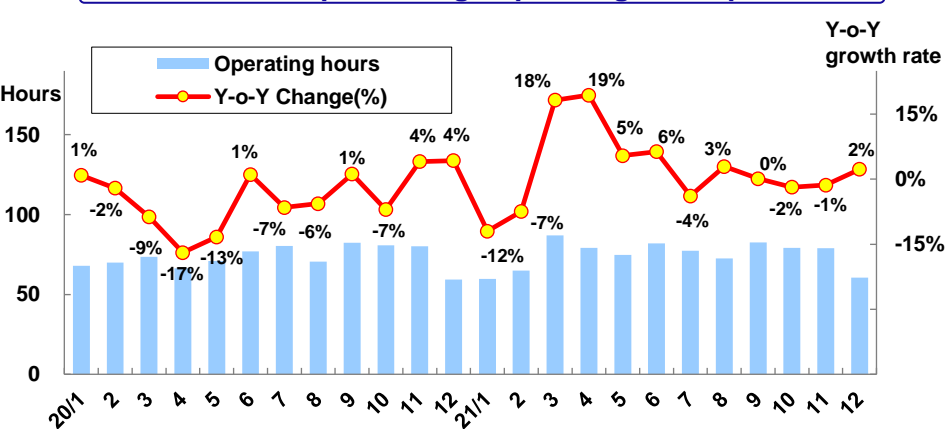

Region demand for 7 major products (Excl. 6t class)

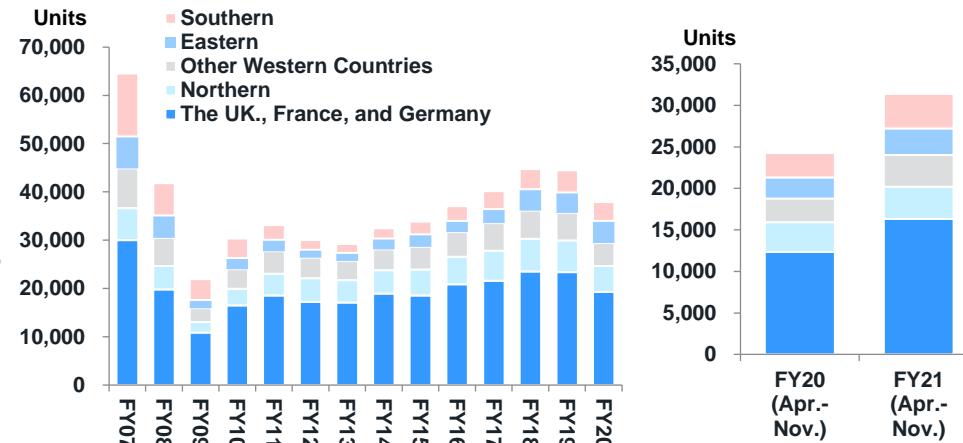

# Construction, Mining & Utility Equipment : Demand in Major Markets (4) China

- In 3Q FY2021, demand decreased by 66% from the corresponding period a year ago.
- Demand dropped sharply, mainly due to the slack infrastructure investment.
- Concerning FY2021 demand, we have revised our projection downward to -60% to -50%.

## Annual demand for hydraulic excavators (Excl. mini shovels)

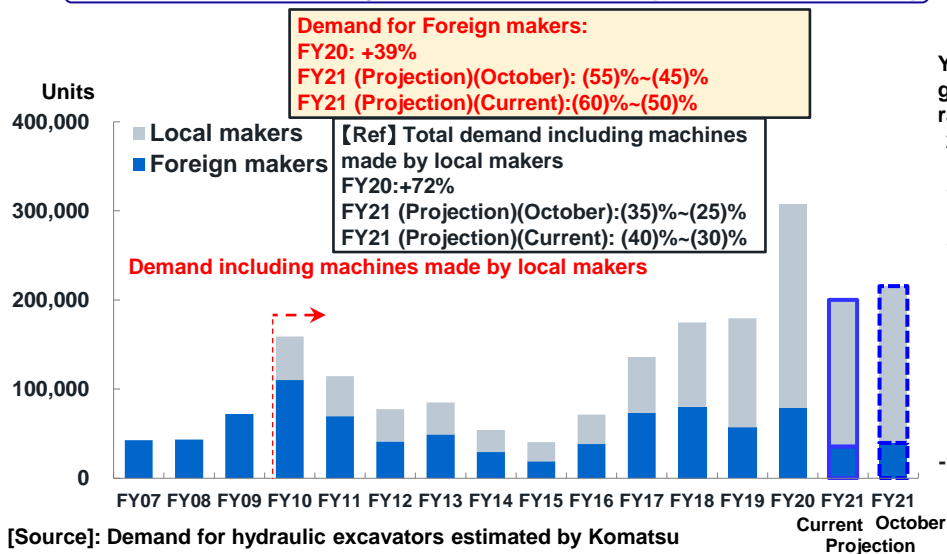

## Quarterly demand for hydraulic excavators (Excl. mini shovels)

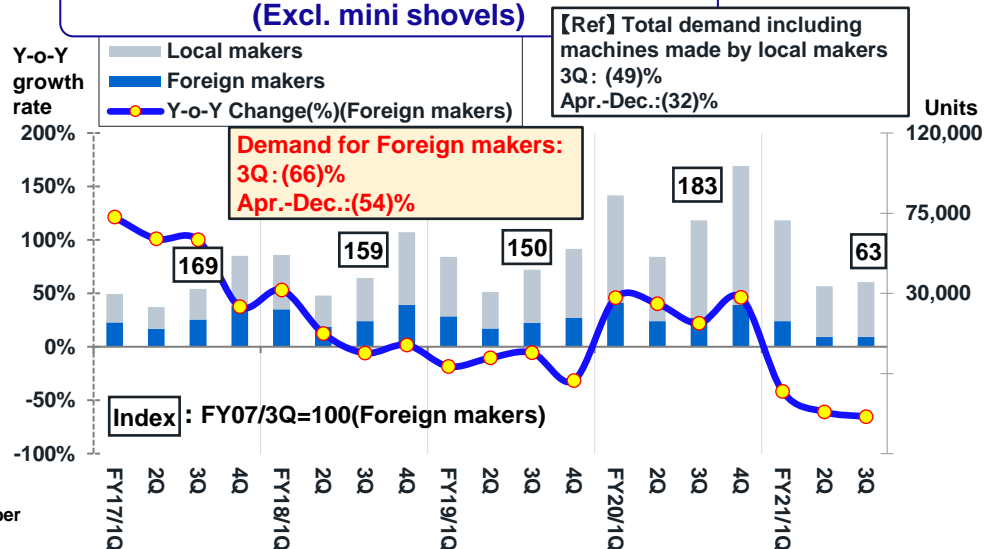

## Komtrax in China : Average operating hours per month

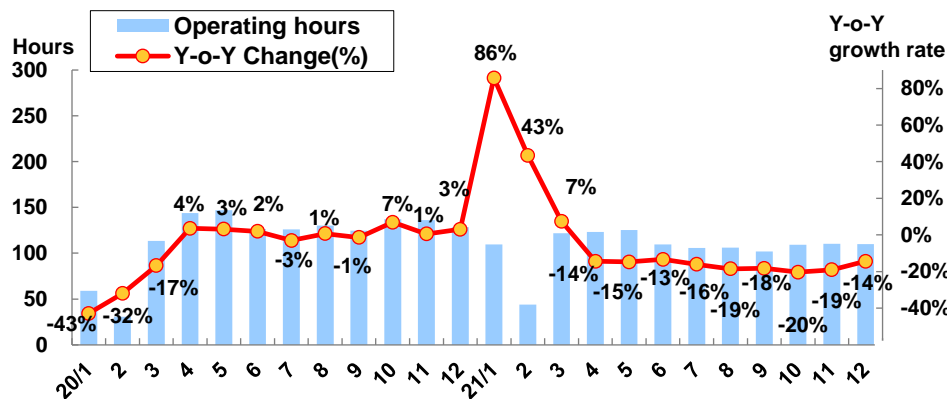

## Monthly demand for hydraulic excavators : (Excl. mini shovels)

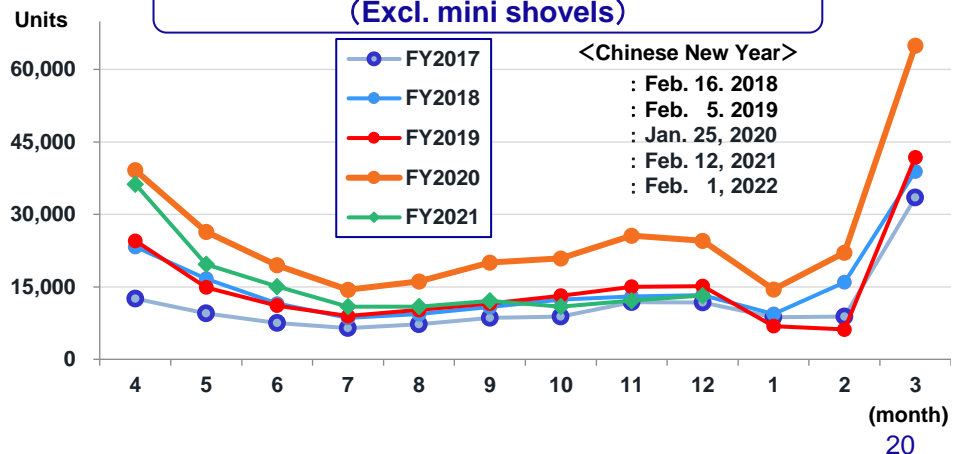



# Construction, Mining & Utility Equipment : Actual and Projected Demand for Mining Equipment

- In 3Q FY2021, global demand for mining equipment advanced by 44% from the corresponding period a year ago.
- Demand increased, centering on Asia, CIS, Chile, and Oceania.
- We project that full-year demand will increase by +30% to +40% in FY2021 from FY2020 (Unchanged from our projection of October 2021).

## Annual demand for mining equipment

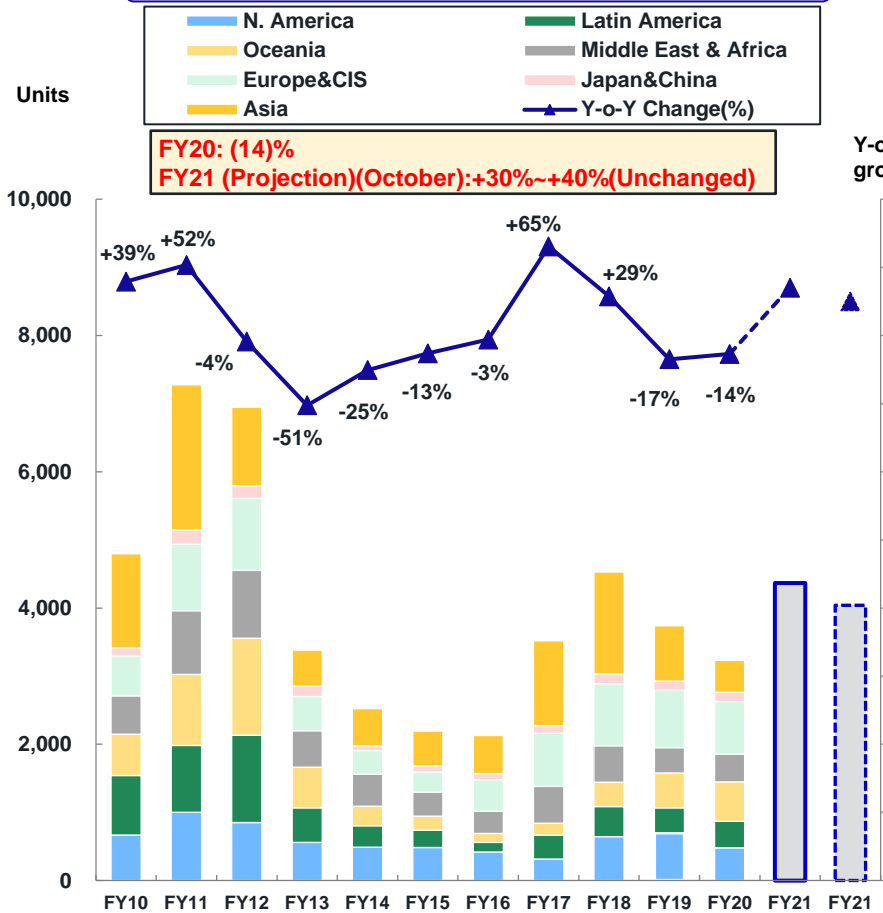

## Quarterly demand for mining equipment

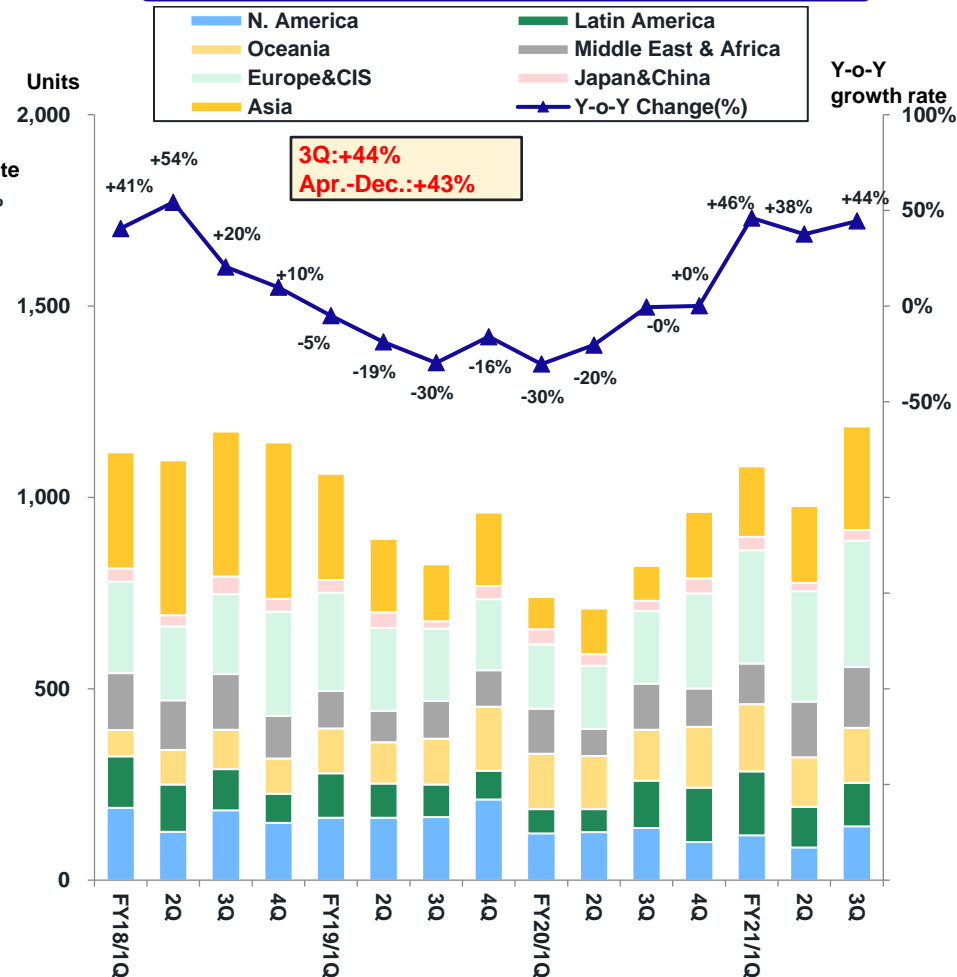

Note: Demand estimated by Komatsu

- Dump trucks: 75 tons (HD785) and larger
- Bulldozers: 525HP (D375) and larger
- Excavators: 200 tons (PC2000) and larger
- Wheel loaders (mechanical driven): 810HP (WA800) and larger
- Motor graders: 280HP (GD825) and larger

# Construction, Mining & Utility Equipment : Sales of Mining Equipment

- In 3Q FY2021, sales increased by 37% from the corresponding period a year ago, to JPY274.7 billion.
- Projection of full-year sales for FY2021 will advance by 31% from FY2020, to JPY1,032.1 billion.

## Annual sales of mining equipment (incl. parts and service)

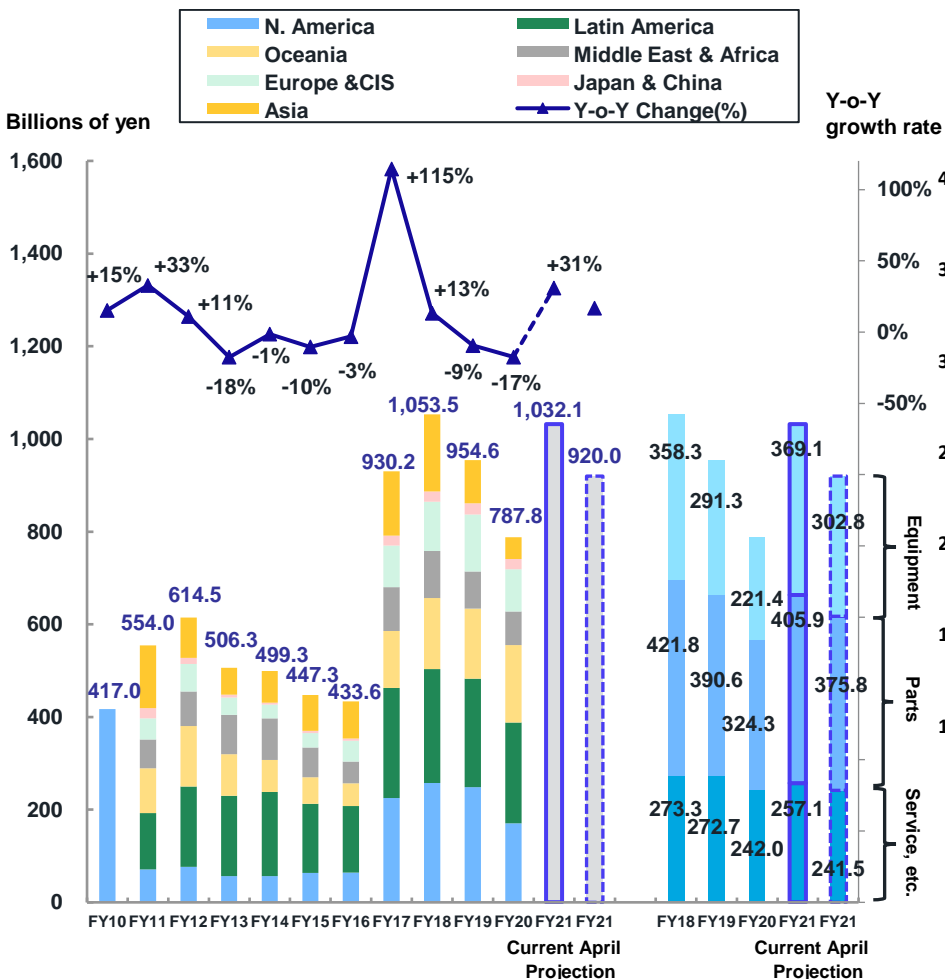

## Quarterly sales of mining equipment (incl. parts and service)

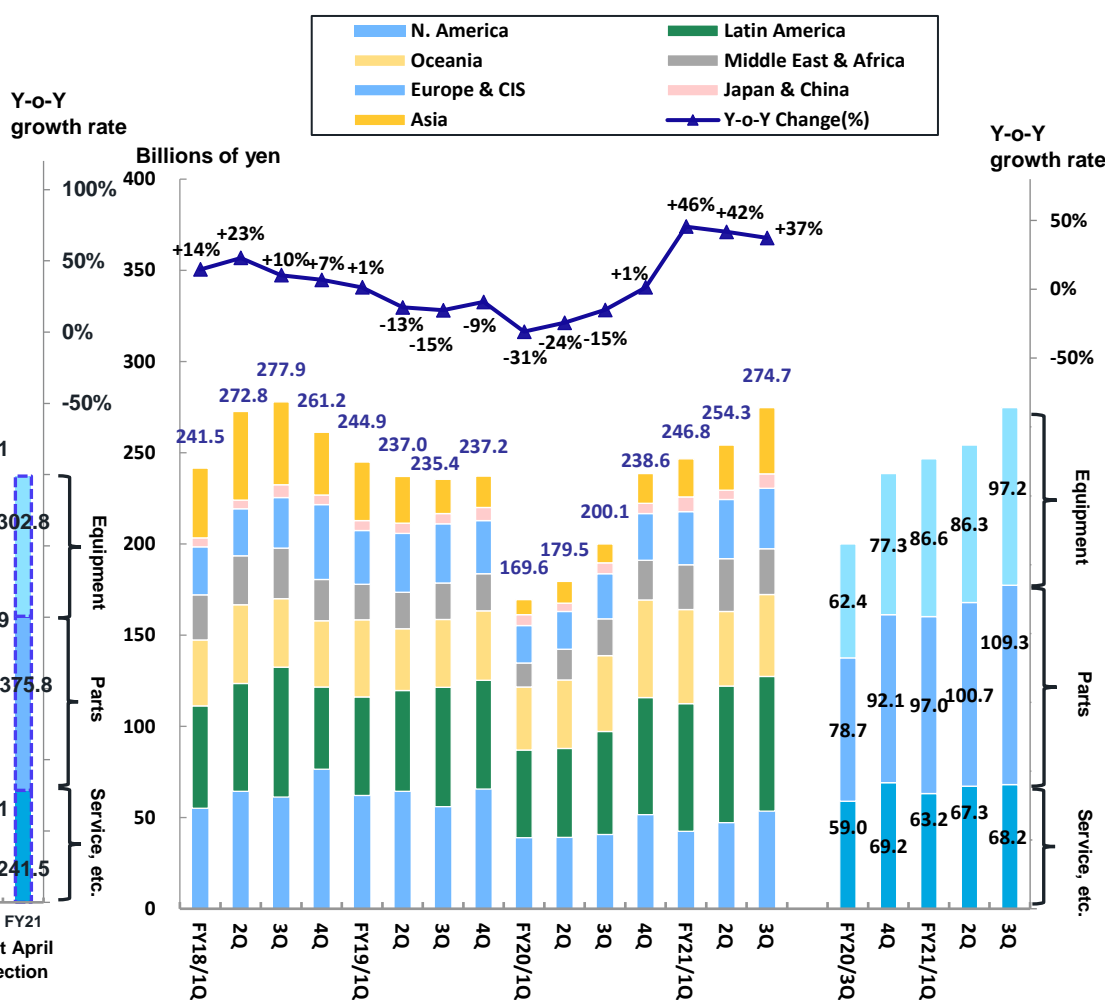

# Construction, Mining & Utility Equipment : Sales of Parts

- For 3Q FY2021, sales of parts increased by 35% from the corresponding period a year ago, to JPY167.6 billion.
- Projection of full-year sales for FY2021 will increase by 22% from FY2020, to JPY618.3 billion.

## Annual sales of parts

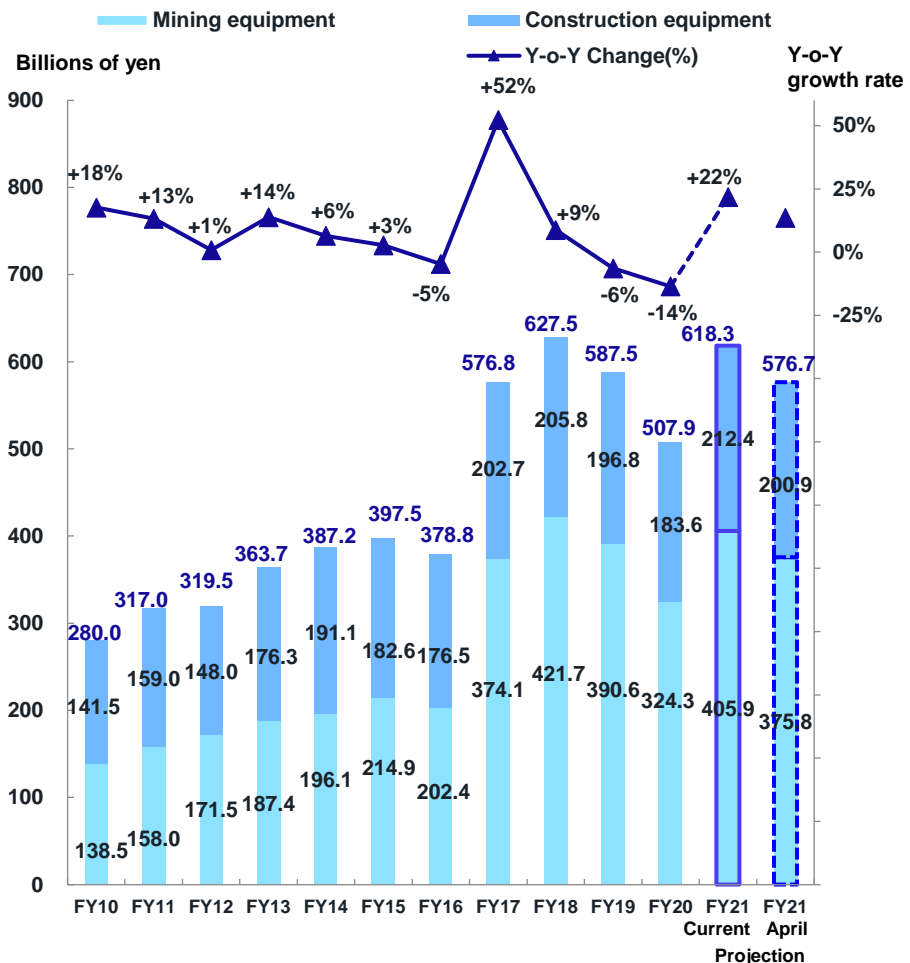

## Quarterly sales of parts

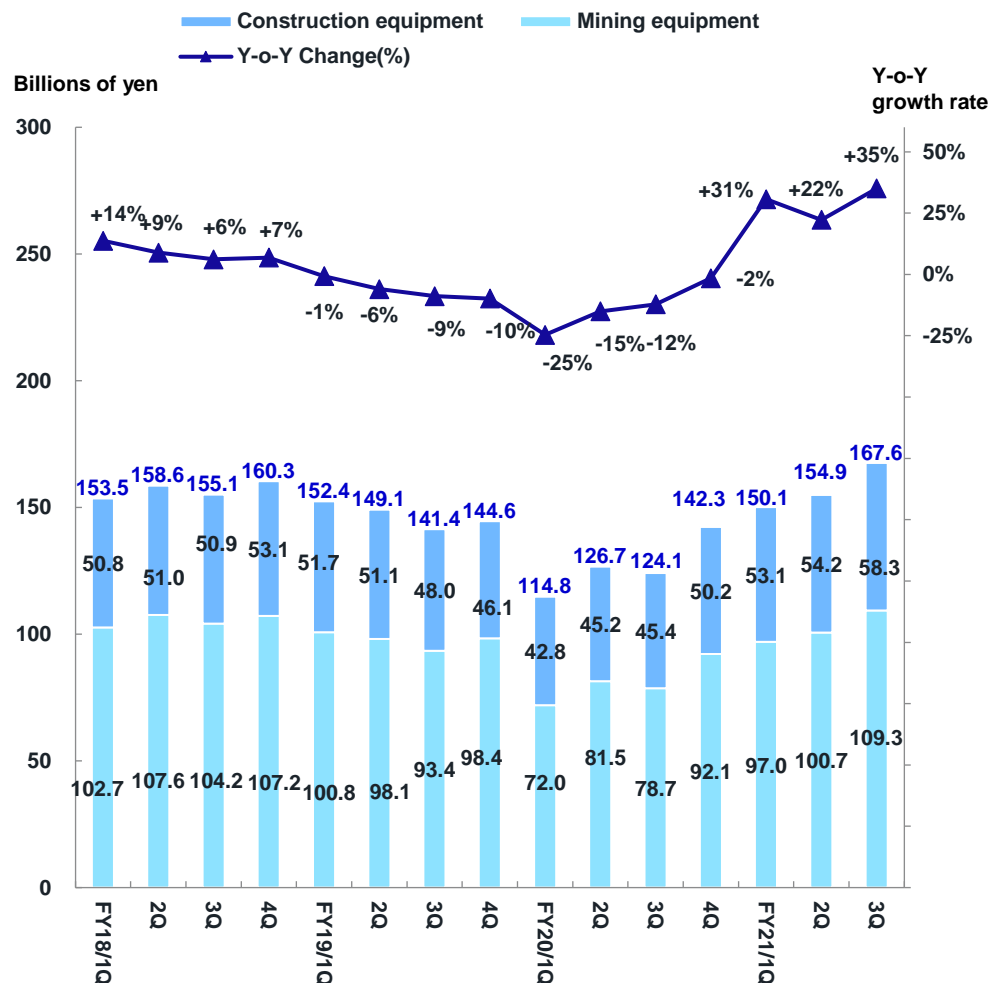



# Appendix

# <Appendix> Daily Komtrax data

## Major European Countries

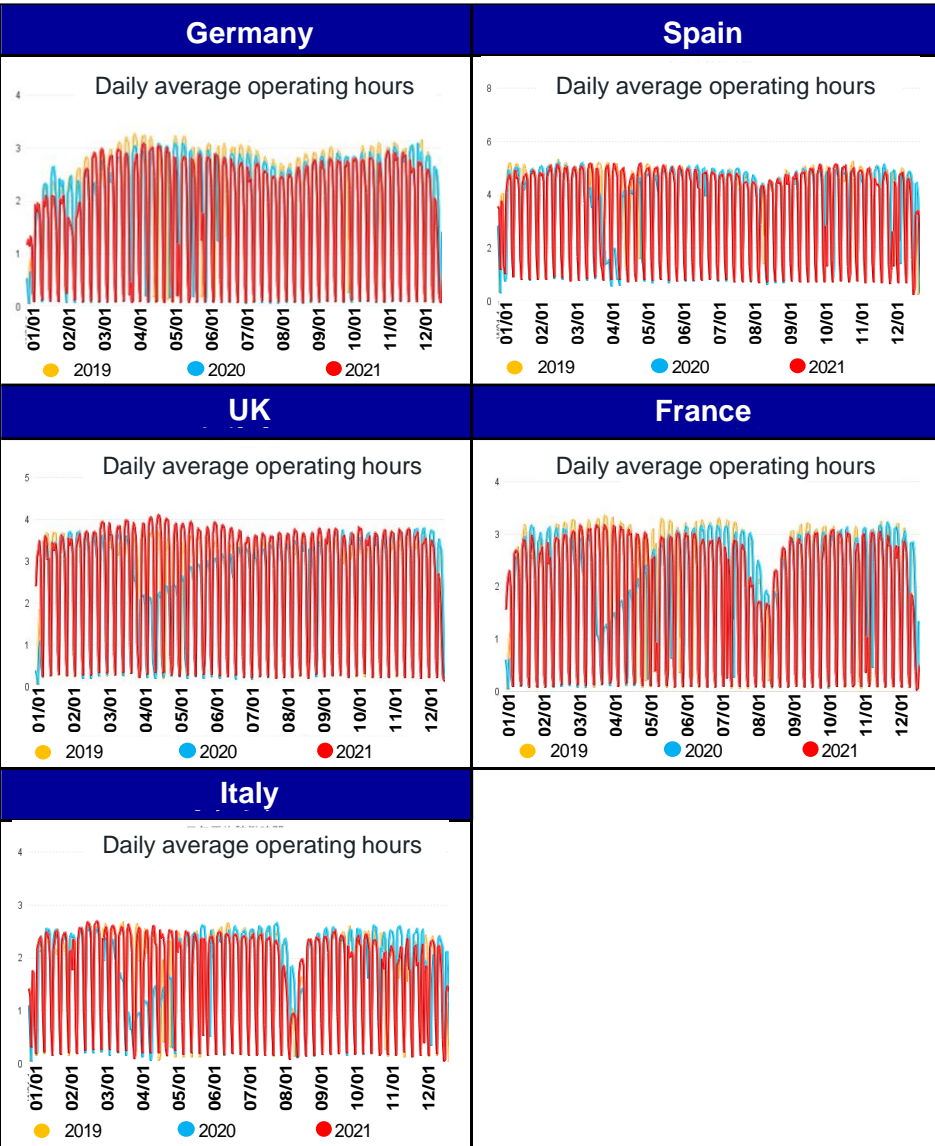

## Other Regions

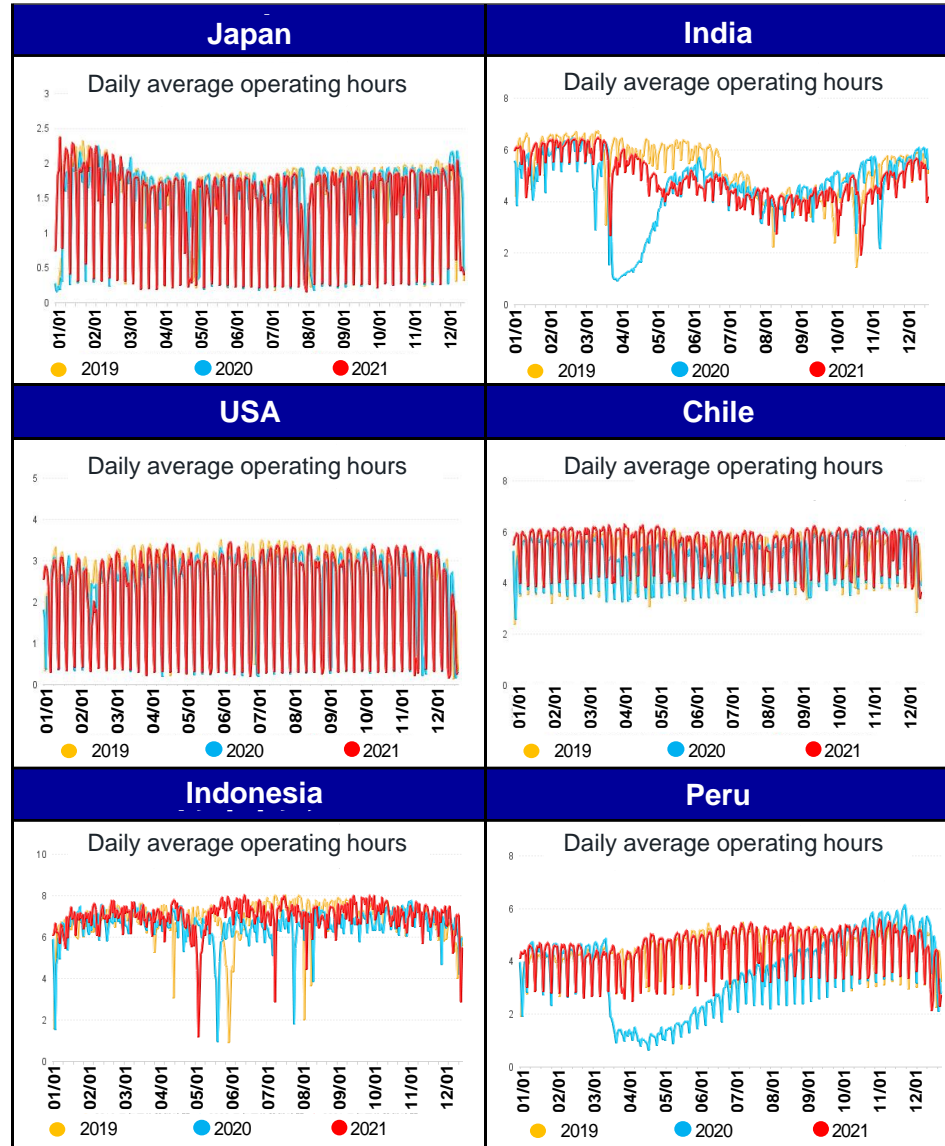

Daily average operating hours: Daily average hours of machine use per unit of Komtrax-installed Komatsu construction equipment .

# <Appendix> Quarterly Sales and Operating Income

## Quarterly sales (Since FY2018)

■ Elimination ■ Construction, Mining & Utility Equipment ■ Retail Finance ■ Industrial Machinery & Others

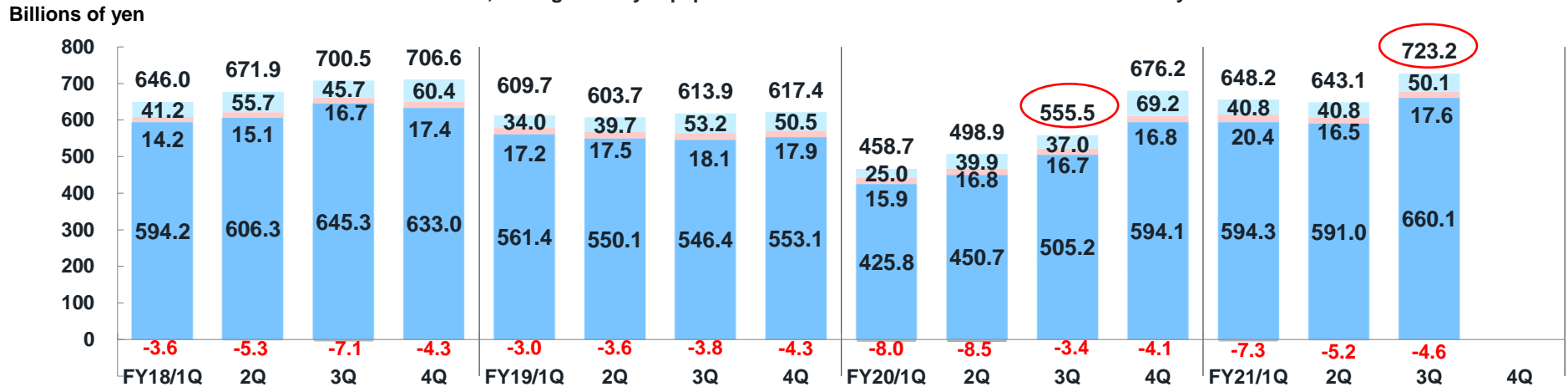

Exchange rates

	18/1Q	18/2Q	18/3Q	18/4Q	19/1Q	19/2Q	19/3Q	19/4Q	20/1Q	20/2Q	20/3Q	20/4Q	21/1Q	21/2Q	21/3Q	21/4Q
¥/USD	108.2	111.2	113.5	109.4	110.0	107.9	108.6	108.1	107.5	106.7	104.9	104.8	109.9	110.3	112.9	-
¥/EUR	130.1	129.6	129.6	124.7	123.2	120.0	119.7	120.0	118.6	124.2	123.4	127.3	131.7	130.6	129.7	-
¥/RMB	17.1	16.4	16.4	16.2	16.2	15.5	15.4	15.5	15.1	15.3	15.7	16.2	17.0	17.1	17.6	-

## Quarterly operating income (Since FY2018)

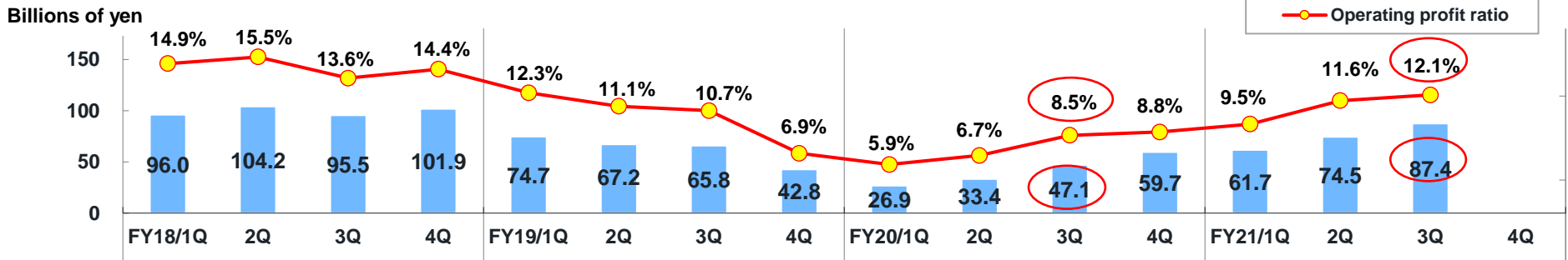

# <Appendix> Construction, Mining & Utility Equipment: Quarterly Sales and Segment Profit

## Quarterly Sales

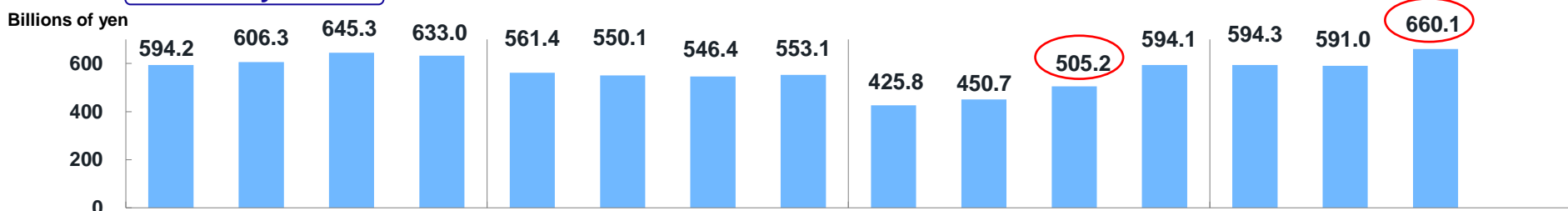

## Exchange rates

	18/1Q	18/2Q	18/3Q	18/4Q	19/1Q	19/2Q	19/3Q	19/4Q	20/1Q	20/2Q	20/3Q	20/4Q	21/1Q	21/2Q	21/3Q	21/4Q
¥/USD	108.2	111.2	113.5	109.4	110.0	107.9	108.6	108.1	107.5	106.7	104.9	104.8	109.9	110.3	112.9	
¥/EUR	130.1	129.6	129.6	124.7	123.2	120.0	119.7	120.0	118.6	124.2	123.4	127.3	131.7	130.6	129.7	
¥/RMB	17.1	16.4	16.4	16.2	16.2	15.5	15.4	15.5	15.1	15.3	15.7	16.2	17.0	17.1	17.6	

## Quarterly segment profit

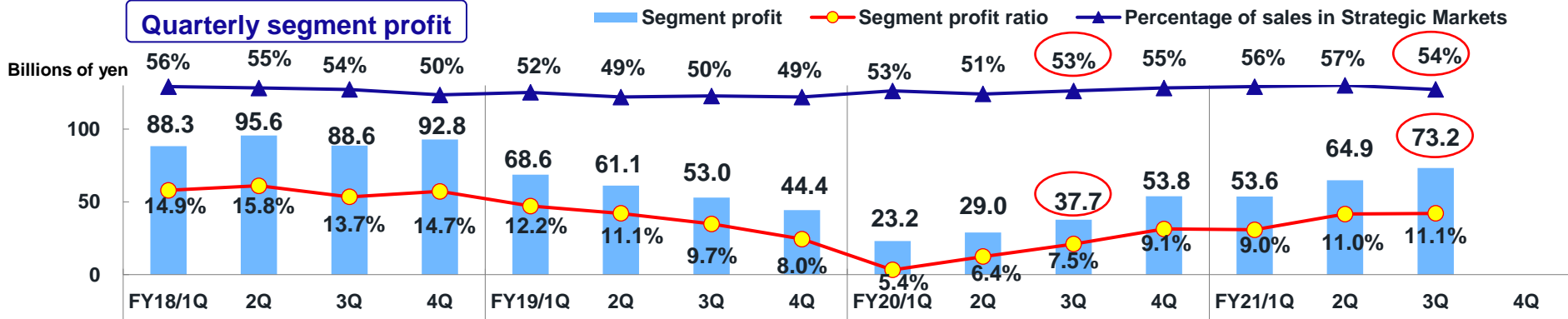

## Breakdown of sales(%)

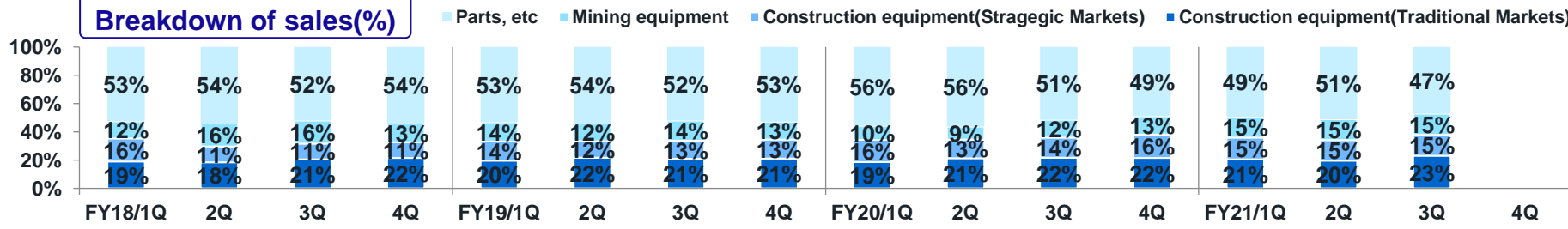

# <Appendix> Construction, Mining & Utility Equipment: Quarterly Sales by Region (To Outside Customers)

Billions of yen

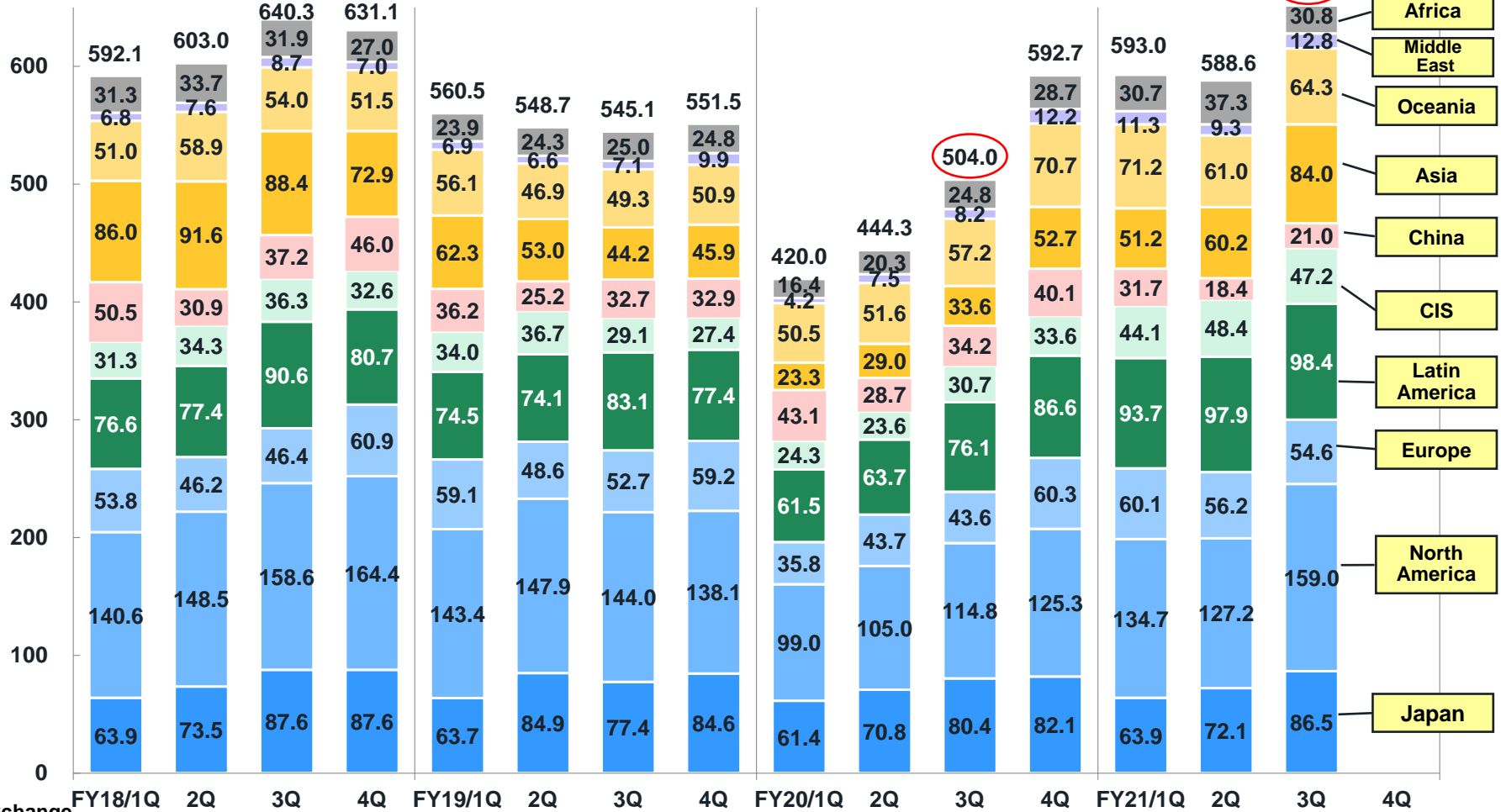

Exchange rates

	18/1Q	18/2Q	18/3Q	18/4Q	19/1Q	19/2Q	19/3Q	19/4Q	20/1Q	20/2Q	20/3Q	20/4Q	21/1Q	21/2Q	21/3Q	21/4Q
¥/USD	108.2	111.2	113.5	109.4	110.0	107.9	108.6	108.1	107.5	106.7	104.9	104.8	109.9	110.3	112.9	
¥/EUR	130.1	129.6	129.6	124.7	123.2	120.0	119.7	120.0	118.6	124.2	123.4	127.3	131.7	130.6	129.7	
¥/RMB	17.1	16.4	16.4	16.2	16.2	15.5	15.4	15.5	15.1	15.3	15.7	16.2	17.0	17.1	17.6	

# <Appendix> Retail Finance: Quarterly Sales and Segment Profit

Billions of yen

Quarterly Sales

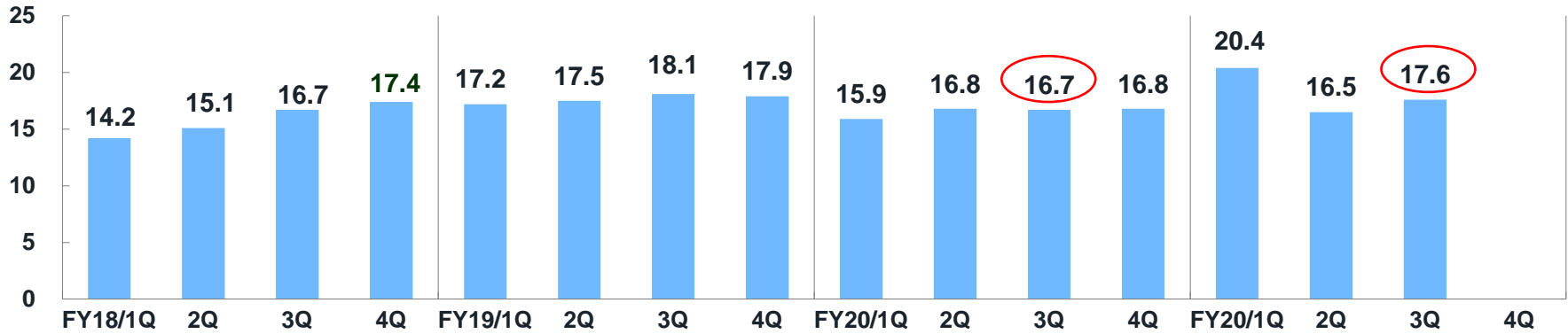

Exchange rates

	18/1Q	18/2Q	18/3Q	18/4Q	19/1Q	19/2Q	19/3Q	19/4Q	20/1Q	20/2Q	20/3Q	20/4Q	21/1Q	21/2Q	21/3Q	21/4Q
¥/USD	108.2	111.2	113.5	109.4	110.0	107.9	108.6	108.1	107.5	106.7	104.9	104.8	109.9	110.3	112.9	
¥/EUR	130.1	129.6	129.6	124.7	123.2	120.0	119.7	120.0	118.6	124.2	123.4	127.3	131.7	130.6	129.7	
¥/RMB	17.1	16.4	16.4	16.2	16.2	15.5	15.4	15.5	15.1	15.3	15.7	16.2	17.0	17.1	17.6	

Quarterly segment profit

Billions of yen

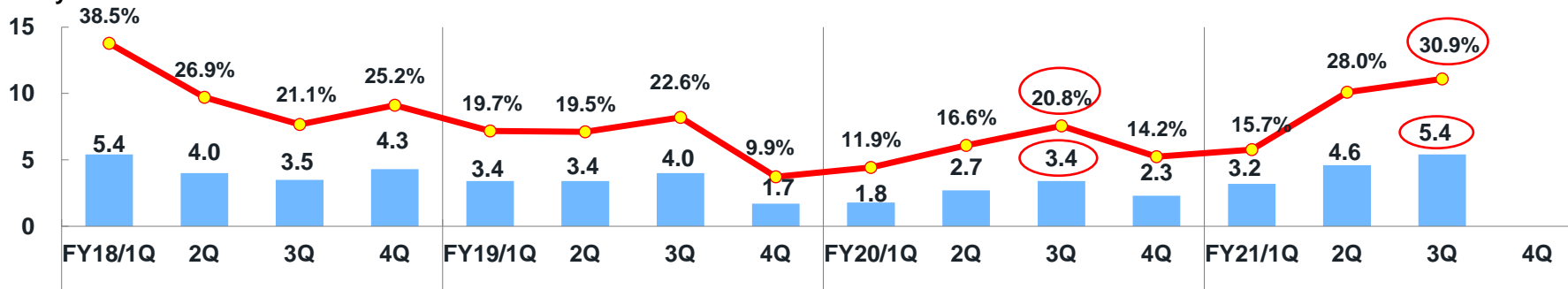

# <Appendix> Industrial Machinery & Others: Quarterly Sales and Segment Profit

Quarterly Sales

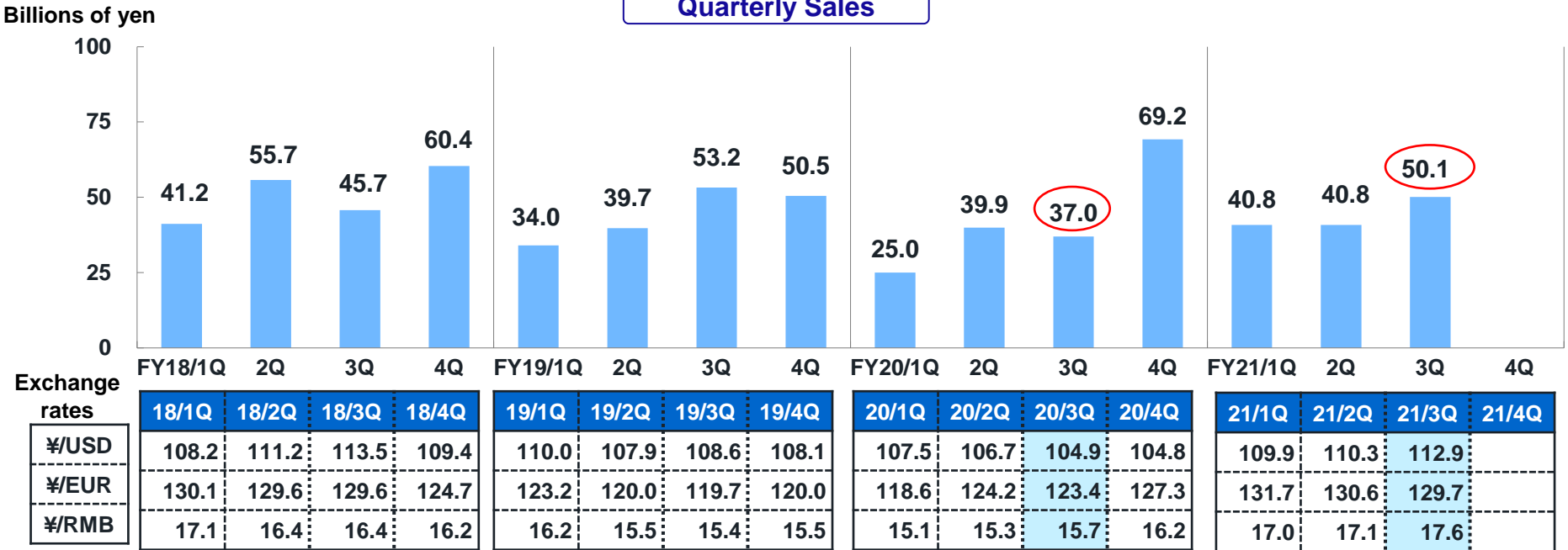

Quarterly segment profit

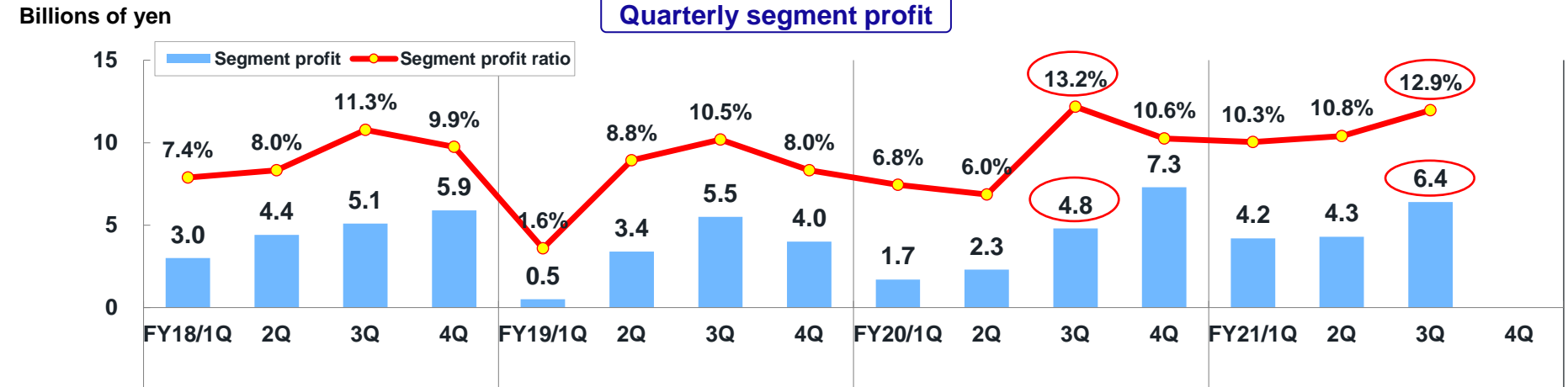

# <Appendix> Book-to-Bill Ratio for Mining Equipment (6 Months)

Avg. orders in value for 6 months / Avg. factory shipment in value for 6 months

## Komatsu America (Mining eqpt)

730E, 830E, 860E  
930E, 960E, 980E

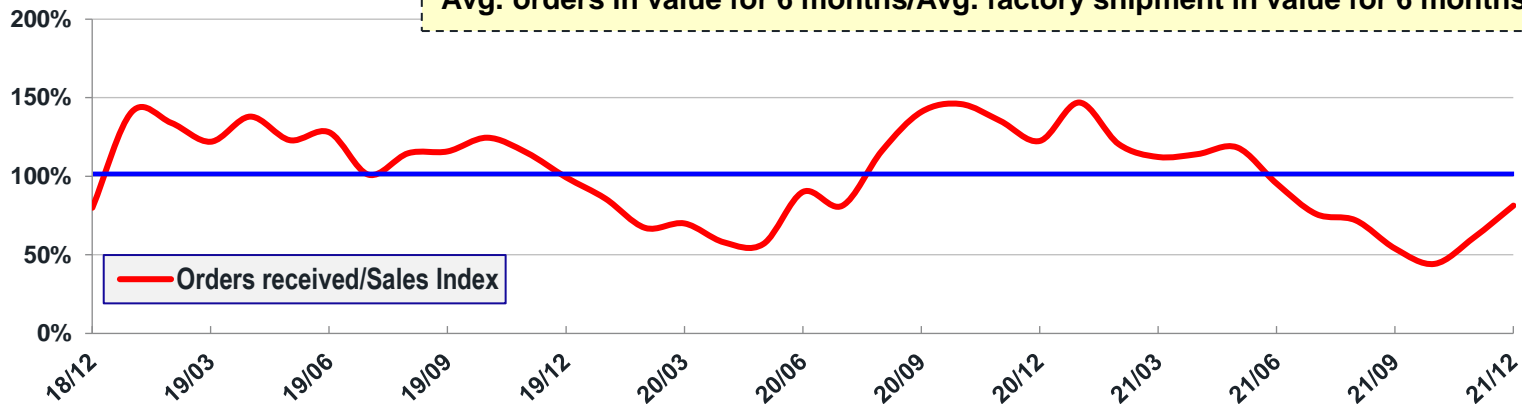

## Komatsu Germany (Mining eqpt)

PC3000, PC4000  
PC5500, PC7000  
PC8000

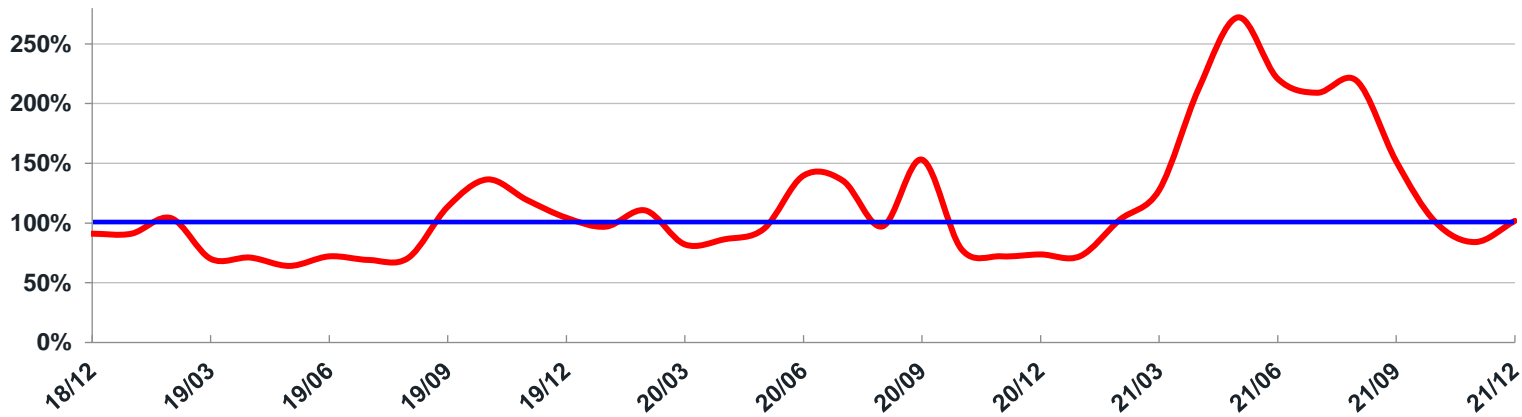

## Komatsu Ltd. (Mining eqpt)

HD785, HD1500  
PC2000, PC3000  
PC4000  
WA800 up  
D375A up  
GD825A up

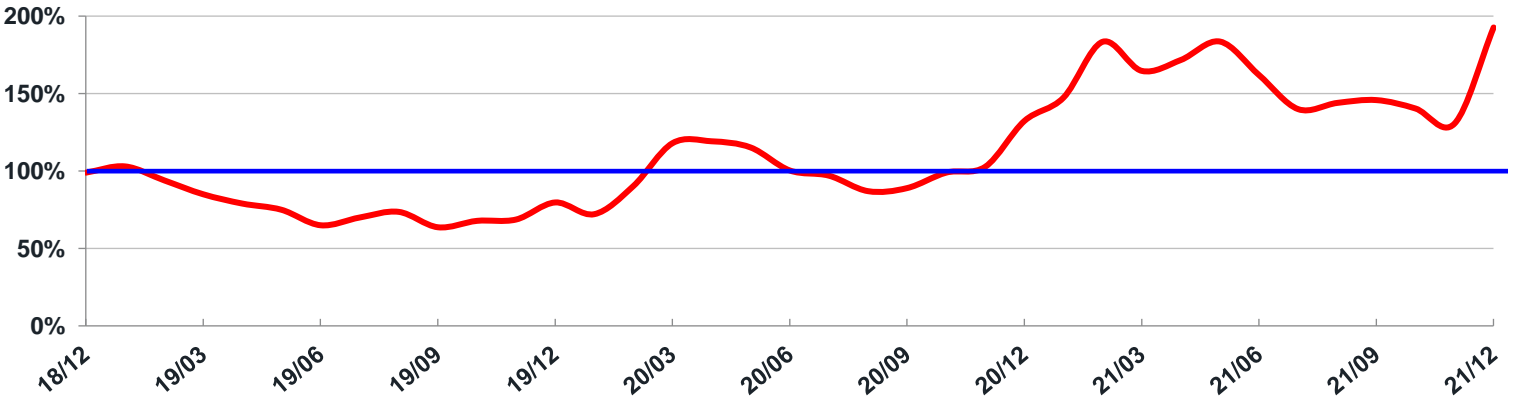



# <Appendix> Book-to-Bill Ratio for KMC Mining Equipment (6 Months)

**KMC  
(Mining eqpt)**

Avg. orders in value for 6 months/Avg. factory shipment in value for 6 months

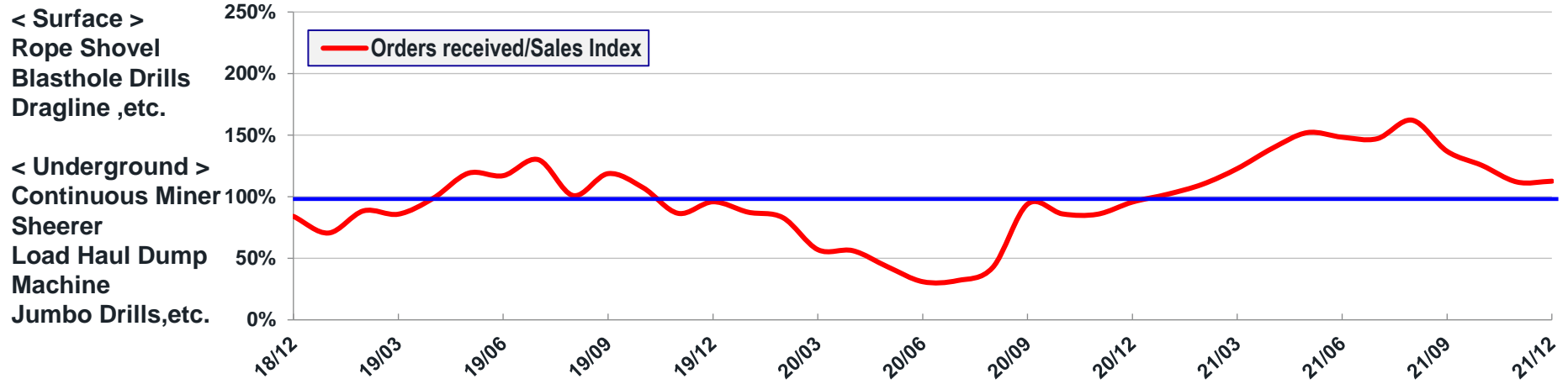

# <Appendix> Book-to-Bill Ratio for Industrial Machinery (6 Months)

## Komatsu Industries

Avg. orders in value for 6 months/Avg. factory shipment in value for 6 months

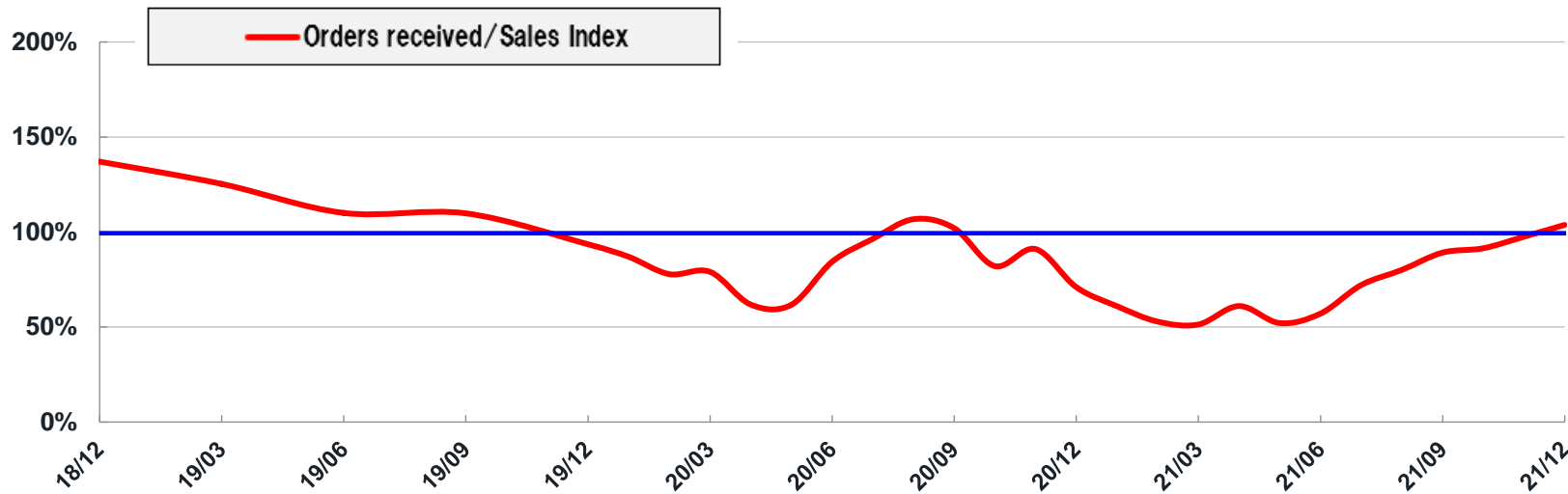

## Komatsu NTC

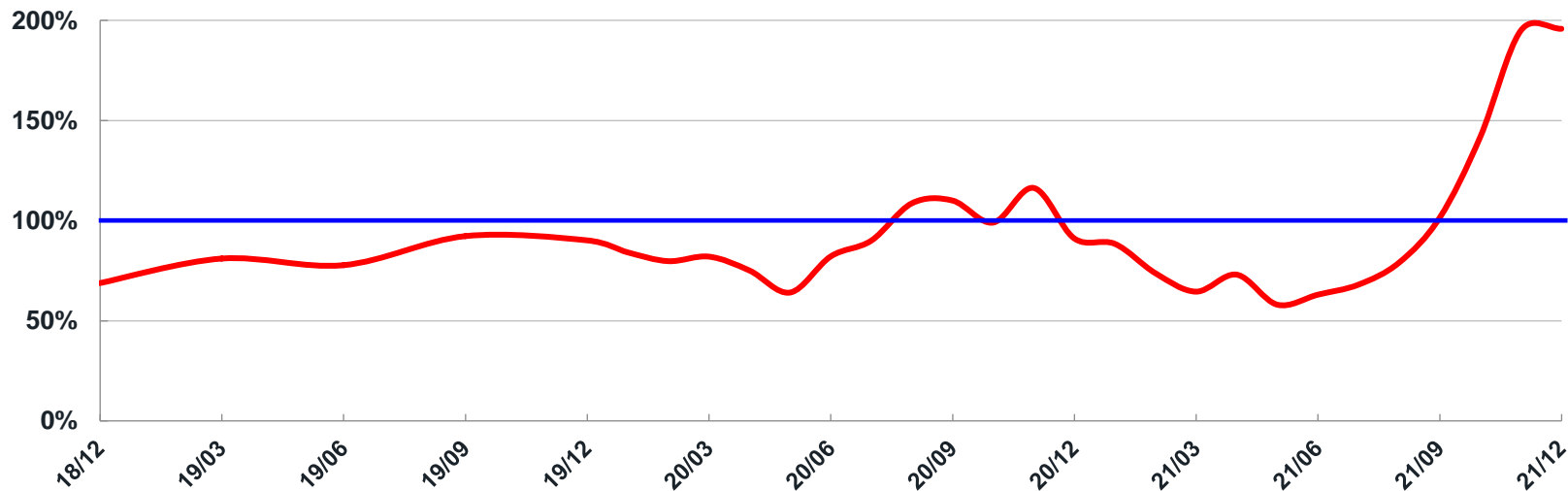

# Accelerating carbon neutrality: Komatsu provides engines and technical cooperation for the development of Denyo's hydrogen co-firing generator

- Komatsu has announced the provision of engines for generators and technical cooperation in the engine field for the development of a 250kW hydrogen co-firing generator that Denyo Co., Ltd. is working on. (News release of Nov. 11, 2021)

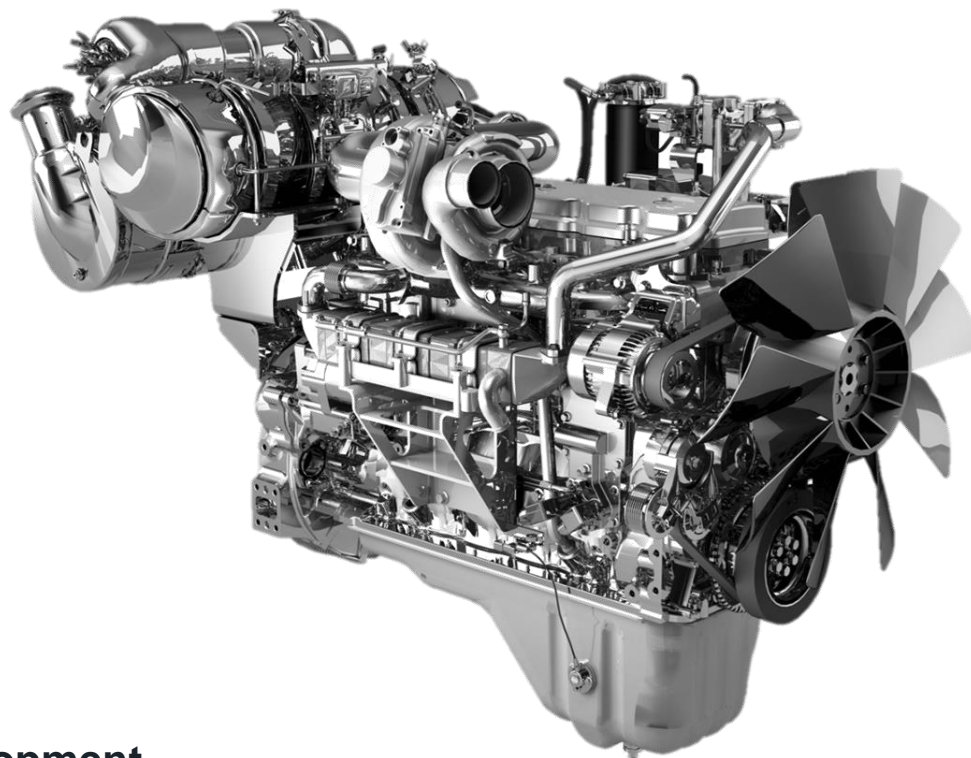

Promoting research and development by taking advantage of its strengths of in-house development and production of engines

## Roadmap of hydrogen engine development



Development will be undertaken in line with this timetable, but the introduction timing will be decided based on the status of infrastructure and other factors.

## Newly released :

# Large bulldozer "D475A-8R" and Large hydraulic excavator "PC2000-11R"

- We launched the D475A-8R, a large bulldozer, and the PC2000-11R, a large hydraulic excavator, in January 2022.
- We have incorporated cutting-edge technologies to thoroughly ensure operator safety and work comfort, and achieved outstanding productivity.

(News release of Jan. 11, 2022)



D475A-8R  
(16% increase in productivity)



PC2000-11R  
(12% increase in productivity)

## Komatsu Selected for Development of Innovative Technologies for Outer Space Autonomous Construction Managed by the Japanese Government: Participating in the Project for Promoting the Development of Innovative Technologies for Autonomous Construction, Such as on the Moon

• As part of the Ministry of Land, Infrastructure, Transport and Tourism's "Strategic Program for Accelerating Space Utilization" (Stardust Program), we applied for the "Project for Promoting the Development of Innovative Technologies for Unmanned Construction in Space" which was decided in July 2021, and our "Construction of Digital Twin Technology for Lunar Construction Equipment" was selected as one of the targets for the implementation of "Technology for Unmanned Construction (Automation and Remote Control).  
(News release of Nov. 18, 2021)

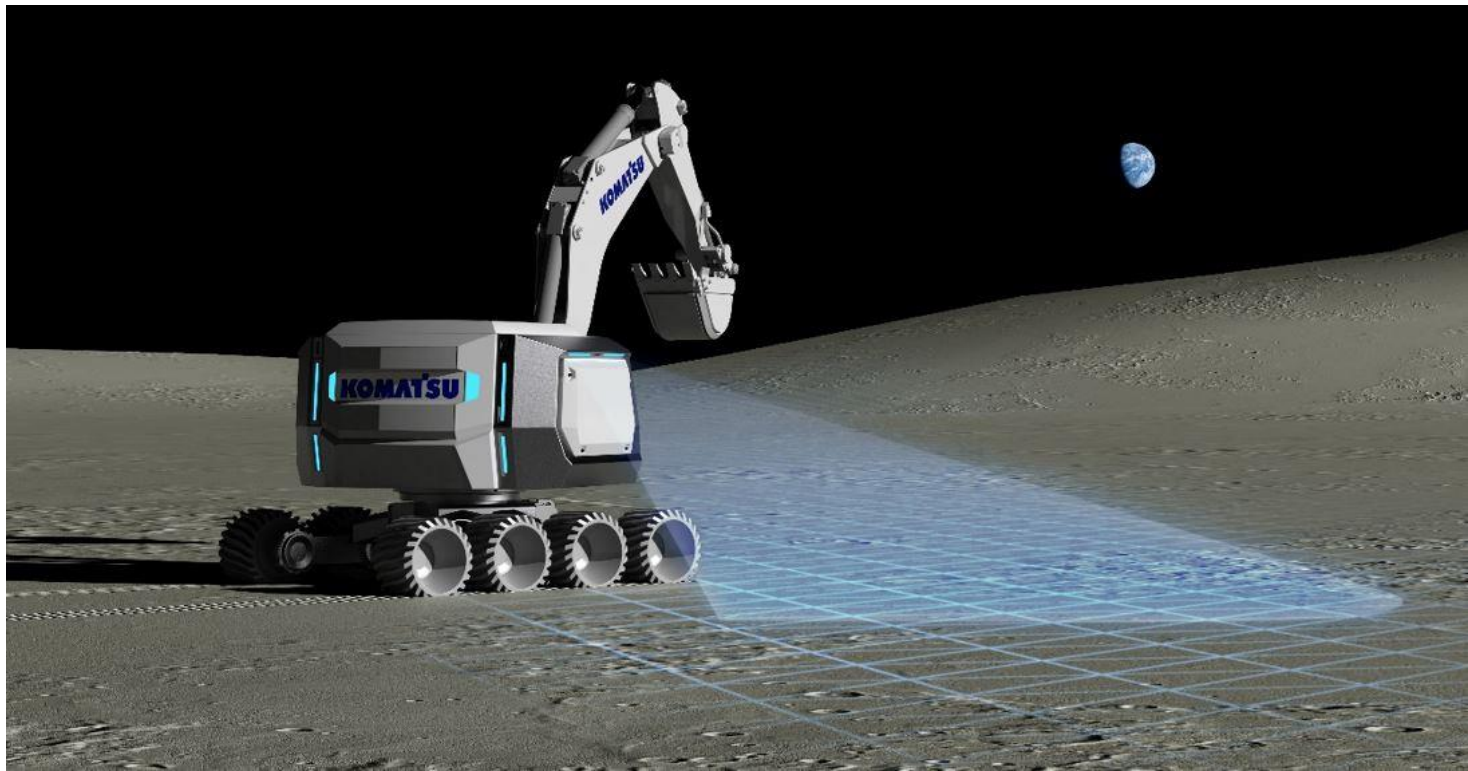

Adaptation of lunar construction equipment by using digital twin technology (conceptual)



# ESG Efforts: Evaluations by External Organizations

Member of

## Dow Jones Sustainability Indices

Powered by the S&P Global CSA

Komatsu was selected as a component of the **Dow Jones Sustainability World Index (DJSI World)** in 2021, an internationally leading SRI index.

(News release of Nov. 15, 2021)



In 2021, **Komatsu was identified as Climate & Water "A" List company by CDP**, the non-profit global environmental disclosure platform.

(News release of Dec. 8, 2021)

### Cautionary Statement

The announcement set forth herein contains forward-looking statements which reflect management's current views with respect to certain future events, including expected financial position, operating results, and business strategies. These statements can be identified by the use of terms such as "will," "believes," "should," "projects" and similar terms and expressions that identify future events or expectations. Actual results may differ materially from those projected, and the events and results of such forward-looking assumptions cannot be assured.

Factors that may cause actual results to differ materially from those predicted by such forward-looking statements include, but are not limited to, unanticipated changes in demand for the Company's principal products, owing to changes in the economic conditions in the Company's principal markets; changes in exchange rates or the impact of increased competition; unanticipated cost or delays encountered in achieving the Company's objectives with respect to globalized product sourcing and new Information Technology tools; uncertainties as to the results of the Company's research and development efforts and its ability to access and protect certain intellectual property rights; and, the impact of regulatory changes and accounting principles and practices.

Business Coordination Department, KOMATSU LTD.

TEL: +81-3-5561-2687 FAX: +81-3-3582-8332 <https://www.komatsu.jp/en>