

KOMATSU

D275A-6

CRAWLER DOZER

D275



CG images may include optional equipment.

HORSEPOWER

Gross: 337 kW 452 HP/2000 min⁻¹
Net: 335 kW 449 HP/2000 min⁻¹

OPERATING WEIGHT

50850 kg

BLADE CAPACITY (ISO 9246)

Semi-U Dozer: 13.7 m³
U Dozer: 16.6 m³

WALK-AROUND

D275A-6



HORSEPOWER

Gross: 337 kW 452 HP/2000 min⁻¹
Net: 335 kW 449 HP/2000 min⁻¹

OPERATING WEIGHT

50850 kg

BLADE CAPACITY (ISO 9246)

Semi-U Dozer: 13.7 m³
U Dozer: 16.6 m³



Ecology & Economy Features

- *Komatsu's U.S. EPA Tier 3 and EU Stage IIIA emissions equivalent engine*
- *Track shoe slip control mode*

Performance Features

- *Selectable working modes*
- *KOMATSU Bogie (K-Bogie) undercarriage system*
- *Power train electronic control system*

Working Environmental Features

- *Hexagonal designed cab*
- *Comfortable ride with cab damper mounts*
- *Palm Command Control System (PCCS)*
- *Fully adjustable suspension seat and travel control console*
- *Height adjustable blade control armrest*
- *Comfortable operator seat* **NEW**
- *LED lights* **NEW**

Reliability & Maintenance Features

- *Liquid Crystal Display (LCD) monitor with troubleshooting function to prevent critical machine troubles*
- *Enclosed hydraulic piping*
- *Modular power train design*
- *Oil pressure checking ports*
- *T-MEX radiator** **NEW** * T-MEX radiator is a trademark of T.RAD Co., Ltd.
- *Maintenance-free battery* **NEW**
- *Battery disconnect switch* **NEW** ● *Tie-offs* **NEW**

Information & Communication Technology (ICT)

- *Large LCD monitor* **NEW**

ECOLOGY & ECONOMY FEATURES

ENGINE TECHNOLOGIES



CG image



Komatsu Engine

The Komatsu SAA6D140E-5 engine delivers 335 kW at 2000 min⁻¹. The fuel-efficient Komatsu engine, together with the heavy machine weight, make the D275A-6 a superior engine. It is U.S. EPA Tier 3 and EU stage IIIA emissions equivalent, and features direct fuel injection, turbocharger, air-to-air aftercooler and cooled Exhaust Gas Recirculation (EGR) system to maximize fuel efficiency. To minimize noise and vibration, the engine is mounted to the main frame with rubber cushions.

Hydraulic Drive Radiator Cooling Fan

Fan rotation is automatically controlled depending on coolant and hydraulic oil temperature, saving fuel consumption and providing great productivity with a quiet operating environment.



D275A-6

Track Shoe Slip Control Mode

Track shoe slip control mode allows the operator not to constantly control engine power output with the decelerator pedal while ripping operation, substantially reducing operator fatigue. Maneuverability is improved because the operator is free to focus on monitoring to track shoe slippage.

Repair costs are significantly lowered and undercarriage life is extended with the reduction in track shoe slippage. Additionally, this mode will contribute to lower fuel costs because the engine output is automatically controlled to optimum level for operation.

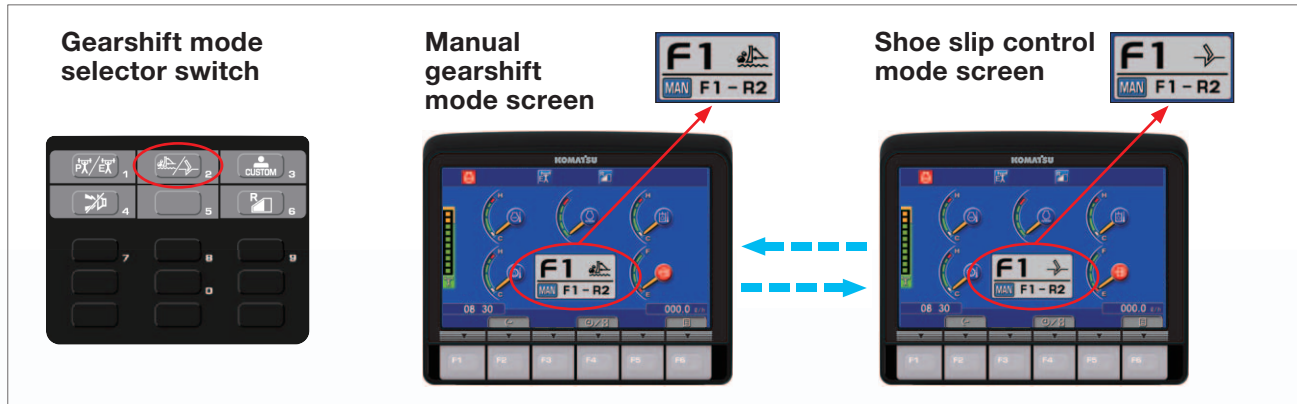

PERFORMANCE FEATURES

Selectable Working Modes

This mode can be set to either “P mode” for the maximum power or “E mode” for energy saving operation. Combined with the manual gearshift mode, the working mode allows the operator to select the optimum machine operating condition for the work at hand. (The mode can be switched during operation.)

- **P Mode** (Power mode)

With P mode, the engine outputs its full power. Select this mode for the work requiring large production, heavy-load work, and uphill work.

- **E Mode** (Economy mode)

Select for energy saving operation with restricted engine power output. Select for the work on a ground where the machine may cause shoe slip and frequent decelerator pedal operation is required. Select for the work not requiring large power such as downhill dozing, leveling, and light-load work.

Working mode selector switch



P mode

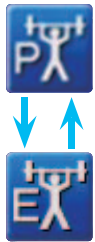

E mode



K-Bogie Undercarriage System

- Effective length of track on ground is consistent. Shoe slippage is minimized; therefore, high traction is obtained.
- The idler does not oscillate under load, providing excellent machine balance. Blade and ripper penetration force remains stable for increased productivity.
- K-Bogies oscillate with two fulcrums, and track roller vertical travel is greatly increased. Impact load on all undercarriage components has been reduced and durability of components is improved since track rollers are always in contact with track link.
- Undercarriage life is improved due to better control of track chain alignment with track rollers.
- Riding comfort is improved by reducing vibration and shock when traveling over rough terrain.

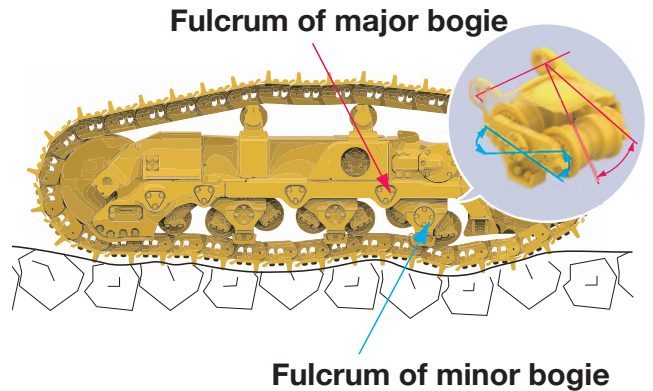

Fulcrum of major bogie

Fulcrum of minor bogie

Power Train Electronic Control System

Smooth and soft operation

D275A-6 utilizes a newly designed power train electronic control system. The controller registers the amount of operator control (movements of lever and operation of switches) along with machine condition signals from each sensor, to calculate accurately the control of the transmission, steering clutches and brakes for optimal machine operation. The ease of operation and productivity of new D275A-6 is greatly improved through these new features.

Electronic Controlled Modulation Valve controlled transmission

Controller automatically adjusts each clutch engagement depending on travel conditions such as gear speed, revolution and shifting pattern. This provides smooth shockless clutch engagement, improved component reliability, improved component life and operator ride comfort.

Electronic Controlled Modulation Valve controlled steering clutches/brakes

Sensors monitor machine operating conditions, and electronically control steering clutches and brakes depending on type of job, such as size of load during dozing, incline angle of slope or load, providing smooth and ease of operation by reducing counter-steering on downhill travel, etc.

Effect of Electronic Controlled Modulation Valve steering clutches/brake control

When dozing and turning, Electronic Controlled Modulation Valve automatically controls stroke ratio of steering clutches and brakes depending on degree of load, enabling smooth dozing and turning.

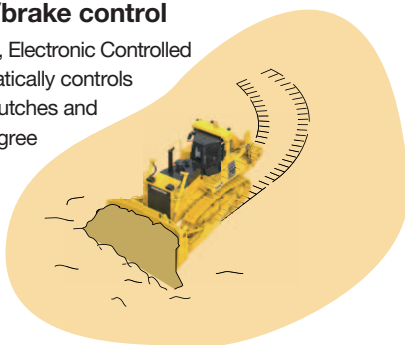

When dozing downhill, Electronic Controlled Modulation Valve automatically controls steering clutches and brakes depending load, reducing counter-steering and producing smooth dozing operation.

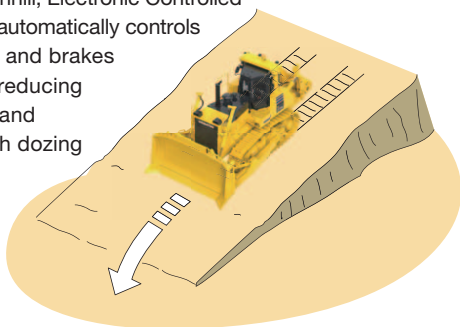

Preset travel speed function

Preset travel speed selection function is standard equipment, enabling the operator to select fore and aft travel speed from three preset patterns; F1-R1, F1-R2 and F2-R2 by using the UP/DOWN switch. When the F1-R2 or F2-R2

preset pattern is selected and the travel control is moved into forward or reverse, the machine travels in the preset gear range automatically. This function reduces manual gear shifting frequency during machine operation, enabling the operator to focus on directional and hydraulic control. Preset travel speed selection is especially helpful when used in combination with the auto-downshift function and reduces cycle times during repeated round trip operations.

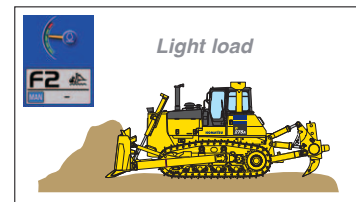
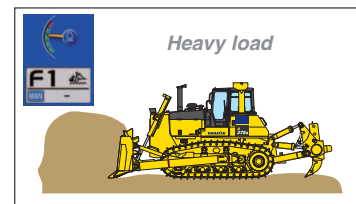
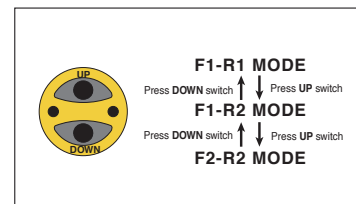

Auto downshift function

Controller monitors engine speed, travel gear and travel speed. When load is applied and machine travel speed is reduced, the controller automatically downshifts to optimum gear speed to provide high fuel efficiency. This function provides comfortable operation and high productivity without manual downshifting.

(This function can be cancelled with cancel switch.)

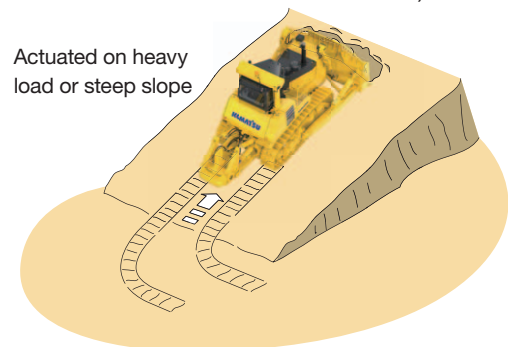

WORKING ENVIRONMENTAL FEATURES



Hexagonal Pressurized Cab

- The cab's hexagonal design and large tinted glass windows provide excellent front, side and rear visibility.
- Air filters and a higher internal air pressure combine to prevent dust from entering the cab.



Fresh Air Intake from Rear of Engine Hood

The air conditioner (A/C) air intake port is now located at the rear of the engine hood where there is minimal dust. As a result, the air inside the cab is always clean. Cleaning interval of the filter is greatly extended, and use of a new structure filter element facilitates cleaning and replacement.

Comfortable Ride with Cab Damper Mounting and K-Bogie Undercarriage

D275A-6's cab mount uses a cab damper mounting which further improves viscous damper and provides excellent shock and vibration absorption capacity with its long stroke. The cab damper mounting, combined with K-Bogie undercarriage, softens shocks and vibrations while traveling over adverse condition that are impossible to absorb with conventional cab mounting methods. The soft spring cab damper isolates the cab from machine body, suppressing vibrations and providing a quiet, comfortable operating environment.

Cab damper mounting

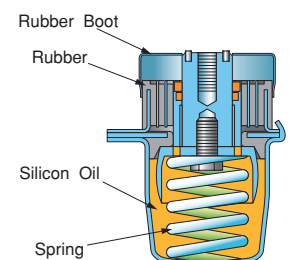

Palm Command Control System (PCCS)

Ergonomically designed palm command travel joystick provides the operator with a relaxed posture and superb control improving operator comfort. Transmission gear shifting is simplified with push buttons.

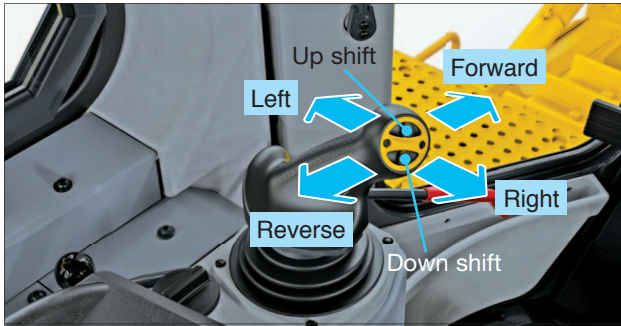

Blade and Ripper Control Joysticks

Blade control joystick uses the Pressure Proportional Control (PPC) valve and the same palm command type joystick as travel control joystick. PPC control, combined with the highly reliable Komatsu hydraulic system, provides superb fine control.



Fully Adjustable Suspension Seat and Travel Control Console

For improved rear visibility during return part of cycle, the operator can adjust the seat 15° to the right. The transmission and steering controls move with the seat for best operator comfort. The travel control console also has adjustments fore and aft and for height. With an independently adjustable armrest, each D275A-6 operator can adjust control positions to his individual preference, providing optimum operational posture for all operators.



Facing front



When turned 15°

Fuel Control Dial

Engine speed is controlled by electric signals, providing ease of operation eliminating maintenance of linkage and joints.

Height Adjustable Blade Control Armrest

Blade control armrest is height adjustable without any tools in three stages, providing the operator with firm arm support and ideal armrest positioning.

Position Adjustable Ripper Control Lever

Ripper control lever is position adjustable, providing optimum operation posture for all operators during ripping operations facing front or watching ripper point.

Comfortable Operator Seat

New air suspension operator seat drastically improves vibration absorption performance. Furthermore, uniformed body pressure management increases contact area with body, which enhances hold performance and fatigue reduction for operator. This seat equips the lumbar support, tilting adjust function, electric heater and ventilator. It is easy to adjust to the various physical size of operator and also the electric heater makes it possible to work comfortably in the winter. And ventilator makes it possible too, in the summer.



LED Lights

LED lights are equipped on of the machine. The visibility under low light environment is improved, and work at night with ease.

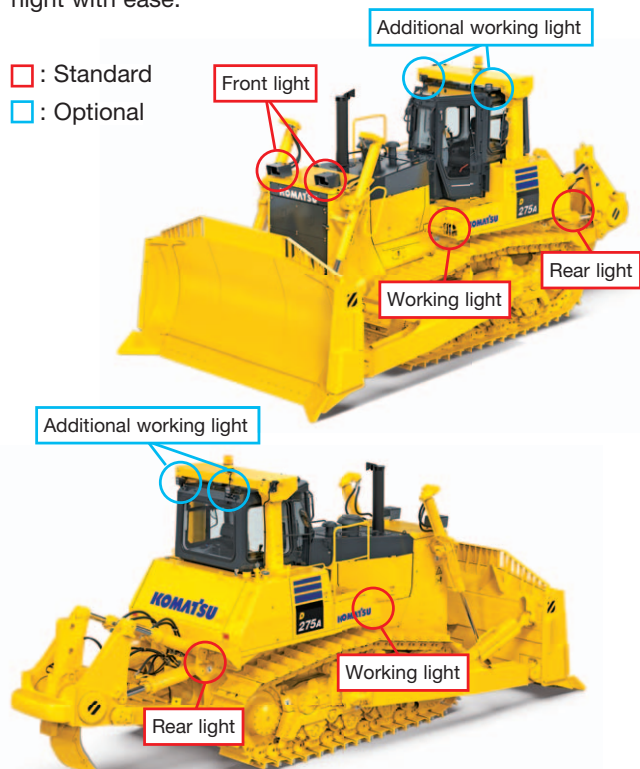

RELIABILITY & MAINTENANCE FEATURES



Preventative Maintenance

Preventative maintenance is the only way to ensure long service life from your equipment. That's why Komatsu designed the D275A-6 with conveniently located maintenance points to make necessary inspections and maintenance quick and easy.

LCD monitor with troubleshooting function to prevent critical machine troubles

Various meters, gauges, and warning functions are centrally arranged on the LCD monitor. Offers ease of start-up inspection and promptly warns the operator with a lamp and buzzer if any abnormalities should occur. In addition, countermeasures are indicated in 4 stage codes to ensure safety and prevent the machine from major problems. Replacement times for oil and filters are also indicated.

Maintenance warning screen



Abnormality warning screen



Maintenance List screen for replacement time display

Enclosed hydraulic piping

Hydraulic piping for the blade tilt cylinder is completely housed in the push arm, ensuring damage protection from materials.

Modular power train design

Power train components are sealed in a modular design that allows the components to be dismantled and mounted without oil spillage.

Oil pressure checking ports

Pressure checking ports for power train components are centralized to promote quick and simple diagnosis.



Maintenance free disc brakes

Wet disc brakes require less maintenance.

Enlarged engine room

Engine room space is enlarged by increasing engine hood height, facilitating maintenance of the engine and related equipment. Perforated holes on the engine hood are discontinued, preventing dust and rain entering and to keep engine area clean.

Gull-wing engine side covers

The opening area is further enlarged when gull-wing engine side covers are opened, facilitating engine maintenance and filter replacement. Side covers have been changed to a thick one-piece structure with a bolt-on catch to improve durability.

T-MEX Radiator*

T-MEX radiator* is equipped as standard cooling system. Easily and individually exchangeable tube and less clogging structure contribute to easy maintenance and less downtime. Damaged tube can be replaced individually instead of replacing whole assembly, which helps maintenance cost reduction or spare parts stock management.

* T-MEX radiator is a trademark of T.RAD Co., Ltd.

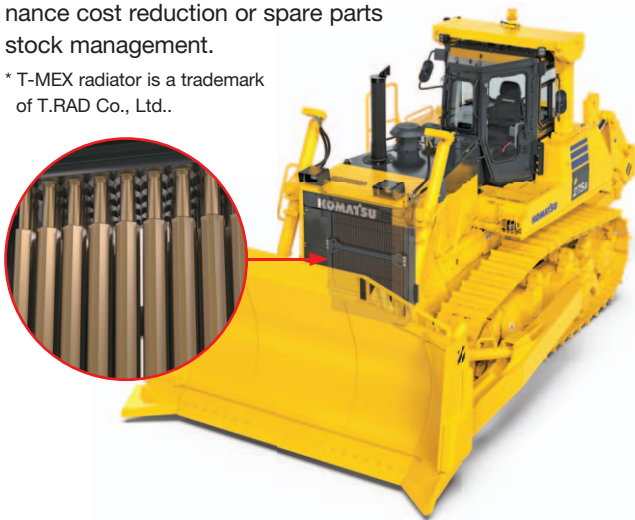

Easy radiator cleaning with hydraulic drive fan

The radiator can be cleaned by utilization of the reversible, hydraulically driven cooling fan. The fan can be reversed from inside the cab by simply pressing the monitor switch.

Maintenance-free battery

Maintenance-free battery saves maintenance time. Operator needs only to check the indicator to know the status. (OK/Charge/Replace)

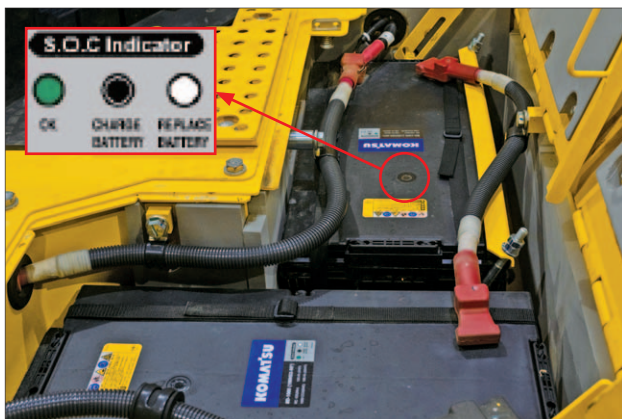

Battery disconnect switch

For machine service work a battery disconnect switch is standard. This switch can be accessed from the ground level.



Tie-offs

Anchor points of tie-off are installed. They are used to connect the safety belts of workers for maintenance and cleaning work.



Low Maintenance Costs

Track link with wedge ring

New D275A-6 track links feature reduced press-fit force and a wedge ring. Conventional track pins are retained only with a large press-fit force. The new track link divides pin forces between the wedge ring and press-fit force. This results in easier service with reduced pin damage when turning pins and bushings. The result is improved undercarriage life and reduced maintenance cost through reduced wear, greater pin reusability, and reduced maintenance man-hours.

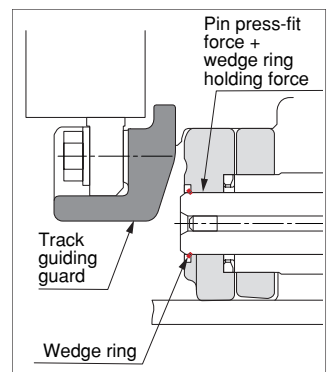



Large LCD Color Monitor

A large user-friendly color monitor enables safe, accurate and smooth work. Improved screen visibility is achieved by use of LCD that can easily be read at various angles and lighting conditions. Simple and easy to operate switches. Industry first function keys facilitate multi-function operations. Display data in 10 languages to globally support operators around the world.

SPECIFICATIONS



ENGINE

Model Komatsu SAA6D140E-5
 Type 4-cycle, water-cooled, direct injection
 Aspiration Turbocharged, air-to-air aftercooled
 Number of cylinders 6
 Bore x stroke 140 mm x 165 mm
 Piston displacement 15.24 L
 Governor All-speed, electronic
 Horsepower
 SAE J1995 Gross 337 kW 452 HP
 ISO 9249 / SAE J1349* Net 335 kW 449 HP
 Rated rpm 2000 min⁻¹
 Fan drive type Hydraulic
 Lubrication system
 Method Gear pump, force lubrication
 Filter Full-flow
 *Net horsepower at the maximum speed of radiator cooling fan 306 kW 410 HP
 U.S. EPA Tier 3 and EU Stage IIIA emissions equivalent.



TORQFLOW TRANSMISSION

Komatsu TORQFLOW transmission consists of a water-cooled, 3-element, 1-stage, 1-phase, torque converter and a planetary gear, multiple-disc clutch transmission which is hydraulically-actuated and force-lubricated for optimum heat dissipation. Gearshift lock lever and neutral safety switch prevent accidental starts.

Gear	Forward	Reverse
1st	3.9 km/h	5.4 km/h
2nd	7.1 km/h	9.4 km/h
3rd	11.5 km/h	15.3 km/h

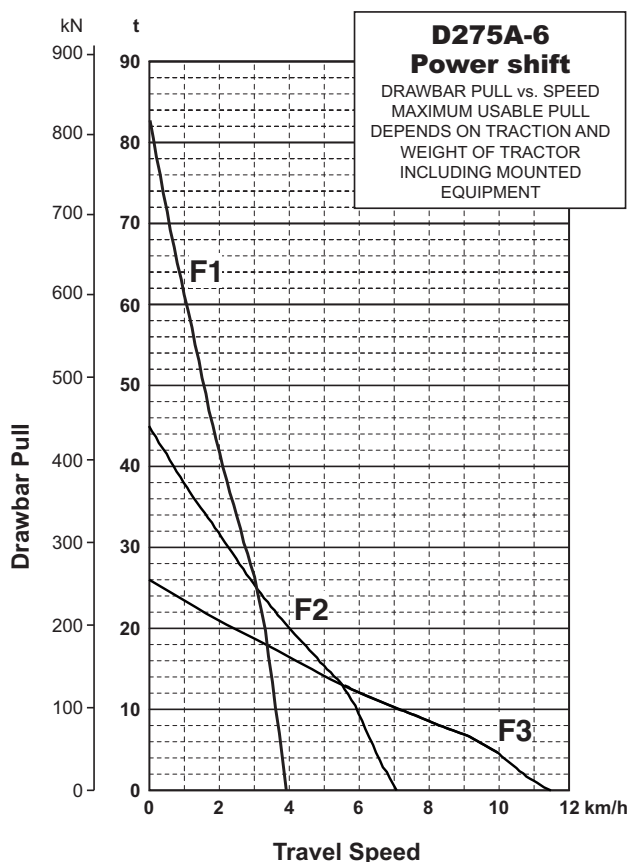

FINAL DRIVES

Double-reduction final drive of spur and planetary gear sets to increase tractive effort and reduce gear tooth stresses for long final drive life. Segmented sprocket rims are bolt-on for easy replacement.



STEERING SYSTEM

PCCS lever controls for all directional movements. Pushing the PCCS lever forward results in forward machine travel, while pulling it rearward reverses the machine. Simply tilt the PCCS lever to left to make a left turn.

PCCS lever, joystick controlled wet multiple-disc steering clutches, hydraulically loaded and hydraulically released. Wet multiple-disc, pedal/lever controlled steering brakes are spring loaded hydraulically released and require no adjustment. Steering clutches and brakes are interconnected for easy, responsive steering. Minimum turning radius 3.9 m



UNDERCARRIAGE

Suspension Oscillating equalizer bar and pivot shaft
 Track roller frame Cylindrical, high-tensile-strength steel construction

Rollers and idlers Lubricated track rollers
 K-Bogie undercarriage

Lubricated track rollers are resiliently mounted to the roller frame with a series of K-Bogies whose oscillating motion is cushioned by rubber pads.

Extreme service track shoes

Lubricated tracks. Unique seals prevent entry of foreign abrasive material into pin to bushing clearances to provide extended service life. Track tension is easily adjusted with grease gun.

Number of shoes (Each side) 39
 Grouser height:

Single grouser 88 mm

Shoe width (Standard) 610 mm

Ground contact area 42456 cm²

Ground pressure (Tractor only) 90.5 kPa 0.92 kgf/cm²

Number of track rollers 7

Number of carrier rollers 2

Extreme Service Shoes	Additional Weight	Ground Contact Area	Ground Pressure*
710 mm	570 kg	49416 cm ²	78.7 kPa 0.80 kgf/cm ²

*Tractor only



COOLANT AND LUBRICANT CAPACITY (REFILL)

Fuel tank (Specified capacity) 840 L

Coolant 100 L

Engine 50 L

Torque converter, transmission,

bevel gear, and steering system 90 L

Final drive (Each side) 40 L



DIMENSIONS

A	2260 mm
B	4300 mm
C	3940 mm
D	1960 mm
E	3480 mm
F	9290 mm
G	3060 mm
H	1395 mm
I	1220 mm
J	4015 mm

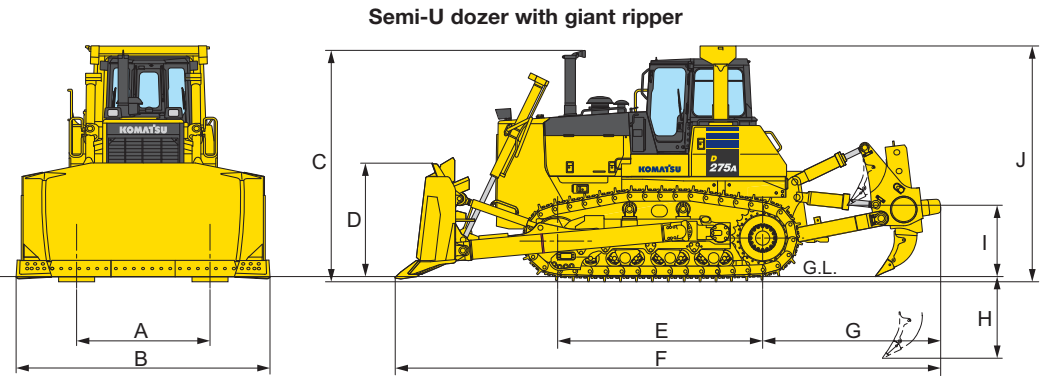

Ground clearance: 507 mm



OPERATING WEIGHT

Tractor weight 40210 kg
Including steel cab, ROPS (ISO 3471), rated capacity of lubricant, coolant, full fuel tank, operator, and standard equipment.

Operating weight 50850 kg
Including Semi-U tilt dozer, giant ripper, operator, standard equipment, rated capacity of lubricant, coolant, and full fuel tank.

Ground pressure 117 kPa 1.20 kgf/cm²



HYDRAULIC SYSTEM

Closed-center Load Sensing System (CLSS) designed for precise and responsive control, and for efficient simultaneous operation.

Hydraulic control units:

All spool valves externally mounted beside the hydraulic tank.

Plunger type hydraulic pump with capacity (Discharge flow) of 230 L/min at rated engine rpm.

Relief valve settingfor implement 27.5 MPa 280 kgf/cm²

Control valves:

Spool control valves for Semi-U tilt dozer and Full-U tilt dozer

Positions: Blade lift Raise, hold, lower, and float

Blade tilt Right, hold, and left

Additional control valve required for variable digging angle multi-shank ripper and giant ripper.

Positions: Ripper lift Raise, hold, and lower

Ripper tilt Increase, hold, and decrease

Hydraulic cylinders Double-acting, piston

	Number of Cylinders	Bore
Blade Lift	2	120 mm
Blade Tilt	1	180 mm
Ripper Lift	2	180 mm
Ripper Tilt	2	160 mm

Hydraulic oil capacity (Refill):

Semi-U dozer or U dozer 130 L

Full-U tilt dozer 130 L

Ripper equipment (Additional volume):

Giant ripper 38 L

Multi-shank ripper 38 L



DOZER EQUIPMENT

Blade capacities are based on the SAE recommended practice J1265.

	Overall Length with Dozer	Blade Capacity	Blade Length x Height	Maximum Lift above Ground	Maximum Drop below Ground	Maximum Tilt Adjustment	Weight		Ground Pressure*
							Dozer Equipment	Hydraulic Oil	
Semi-U Tilt Dozer	6930 mm	13.7 m ³	4300 mm x 1960 mm	1475 mm	615 mm	1000 mm	7020 kg	29 kg	117 kPa 1.20 kgf/cm ²
Full-U Tilt Dozer	7265 mm	16.6 m ³	4615 mm x 1973 mm	1475 mm	615 mm	1070 mm	8150 kg	29 kg	120 kPa 1.22 kgf/cm ²

* Ground pressure shows tractor, cab, ROPS (ISO 3471), operator, giant ripper standard equipment and applicable blade.



STANDARD EQUIPMENT FOR BASE MACHINE

- Alternator, 24 V/75 A
- Backup alarm
- Blower fan
- Decelerator pedal
- Dry-type air cleaner with dust evacuator and dust indicator
- Final drive case wear guard
- Hinged underguard with front pull hook
- Hydraulic track adjusters
- LED lights
(Including four front and two rear lights)
- Maintenance-free batteries, 2 x 12 V/140 Ah
- Muffler with rain cap
- Palm lever steering control
- Perforated single radiator mask
- Radiator reserve tank
- ROPS (ISO 3471) brackets
- Seat
Air suspension seat with shock damper
Suspension seat
— Fabric seat
— Fabric seat, high backrest
- Segmented sprockets
- Seven-roller track frames
- Shoes, 610 mm extreme service, single-grouser
- Starting motor, 11 kW/24 V
- Steel cab (ISO 3449 FOPS standard)
- TORQFLOW transmissions
- Torque converter
- Track roller guards
- Track shoe slip control system
- Warning horn
- Wet steering clutches/brakes



OPTIONAL EQUIPMENT

- Additional LED Lights (Cab)
(Two for front, two for rear)
- Air conditioner (A/C) with heater and defroster
- Counterweight
- Cushion push block
- Fire extinguisher
- Hinged front mask
- Hitch
- Hydraulics for ripper
- Light for ripper point
- Mirror, rearview
- Pusher plate
- Radio, stereo
- Seat belt
- Shoes:
— 710 mm
— 760 mm
- Spill guard for Semi-U dozer
- Spill guard for U dozer
- Strengthened Semi-U blade
- Strengthened U blade
- Sun visor
- Vandalism protection kit

Multi-shank ripper:

Hydraulically controlled parallelogram ripper with three shanks. Ripping angle infinitely adjustable.

Weight (Including hydraulic control unit)
..... 4440 kg
Beam length 2495 mm
Maximum lift above ground 980 mm
Maximum digging depth 875 mm

Variable giant ripper:

Variable, parallelogram single-shank ripper ideal for ripping up tough material. Ripping angle is infinitely adjustable. Ripping depth is adjustable in three stages by a hydraulically controlled pin puller.

Weight (Including hydraulic control unit)
..... 3620 kg
Beam length 1252 mm
Maximum lift above ground ... 1220 mm
Maximum digging depth 1395 mm

Up to 20% blended biodiesel fuel and paraffine fuel can be used. Please consult your Komatsu distributor for detail.

<https://www.komatsu.jp/en>

Printed in Japan 202111 IP.As

