

Development of a Technique to Predict the Level of Dynamic Noise of Hydraulic Excavators

Mikio Iwasaki

Reducing the noise of construction equipment is strongly demanded by the market. In order to put on the market a new, high-quality product which meets the demand, it is necessary to predict its noise problems and solve them beforehand.

Recently, we developed a new technique to simulate the level of ambient noise (dynamic noise) of a hydraulic excavator in operation. It uses the design data about the hydraulic excavator and the levels of noise produced by its components, rather than relevant data obtained in the past. This paper describes the newly-developed simulation technique.

Key Words: Dynamic Noise Level, Acoustic Power Level, New EU Order, Simulation, EXCEL File

1. Background to development of new technique

1.1 Shortening period of development of new construction equipment

In order to supply the market with an overwhelmingly good product at the right time, it is indispensable to develop it in a short period of time. In the development of a new hydraulic excavator, solving its noise problems is one of the most time-consuming processes involved in tuning its performance. Therefore, it is not too much to say that the period of development of a new hydraulic excavator depends on how fast the level of its noise can be predicted accurately and how many effective measures are available to address its noise problems (reducing noise level, preventing unusual sounds, improving sound quality, etc.). Because of this, there is a strong demand for a new technique which permits “predicting the level of noise of a new hydraulic excavator accurately” and “planning effective measures to reduce the level of noise.”

1.2 Complying with the EU regulations

The EU Order 2000/14/EC sets limitations on the acoustic power levels of all construction machines whose engine output is less than 500 kW and which are exported to countries of the EU.

The acoustic power level of construction equipment is calculated as follows. First, equivalent noise level of the construction equipment during simulative excavation operation is measured at six points on a hemisphere which surrounds the construction equipment (Fig. 1). Then, the measured values are averaged in terms of energy into a dynamic noise level with consideration given to the attenuation by distance. The formula for calculation is given below.

$$L_{WA} = L_{AeqT} + 10\text{Log}(S/S_0) \dots\dots\dots 1)$$

L_{WA} : Acoustic power level dB(A)

L_{AeqT} : Energy average of equivalent noise levels at 6 points dB(A)

S : Surface area of hemisphere m²

S_0 : Reference area 1.0m²

The acoustic power levels currently set for hydraulic excavators are based on the following equation.

When $15 \leq P$ $L_{WA} = 96 \text{ dB(A)}$ 2)

When $15 < P$ $L_{WA} = 83 + 11\text{Log}(P)$ 3)

L_{WA} : Acoustic power level of hydraulic excavator dB(A)

P : Net engine output kW

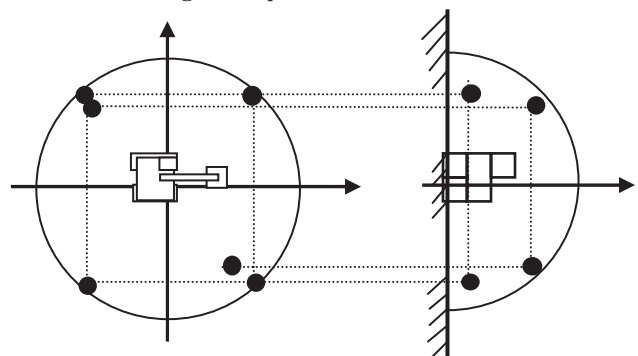

Fig. 1 Dynamic noise level measuring points

The revised EU Order requires that the acoustic power level of every construction equipment sold in any of the countries of the EU in and after January 2006 should be 3 dB(A) lower than the current regulatory value.

Looking at only the hydraulic excavators manufactured by Komatsu, more than 30 models, ranging in machine weight from 0.3 ton to 110 tons, are subject to the revised EU Order. Therefore, it is of urgent necessity for us to reduce their acoustic power levels. To reduce the acoustic power levels of so many models within the limited period of time, we must be able to analyze them speedily and easily. This calls for a new analytical system which can be used even in the field, unlike such analytical tools as FEM and SYSNOISE.

2. Conventional noise prediction method and its problems

2.1 Conventional noise prediction method

The calculation method that has been most commonly used to predict the dynamic noise level of a newly-developed hydraulic excavator is this. From a bench test on the contribution to noise of each of the components of an existing machine (① in Fig. 2), it is realized that the noise level of the muffler (② in Fig. 2) can effectively be reduced. First, therefore, the amount of reduction in noise level of the muffler is deducted from the noise level of the newly-developed machine. Then, the noise levels of all the components are added up in terms of energy to predict the dynamic noise level of the newly-developed machine (③ in Fig. 2).

This method is also used in the study of measures to reduce the dynamic noise level of a newly-developed machine. Namely, the effects of those measures are predicted based on the actual effects of measures taken with existing machines.

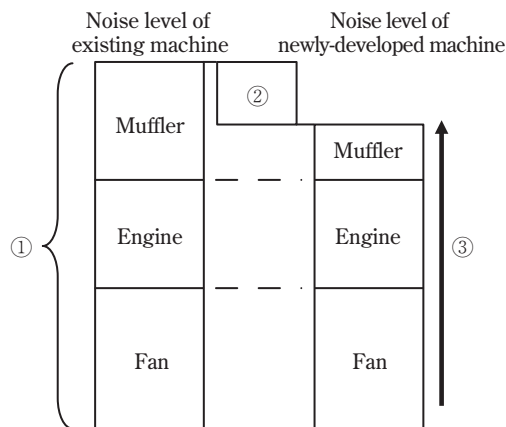

Fig. 2 Conventional noise prediction method

2.2 Problems in conventional prediction technique

- (1) Necessity of studying contributions to noise of individual components of existing machine

With the conventional prediction method, it is necessary to study the contribution to the dynamic noise level of each of the components of an existing machine in order to predict the dynamic noise level of a newly-developed machine.

The contribution to dynamic noise level of each individual component is measured by extracting the dynamic noise level of each component by: ① installing a large muffler to reduce the exhaust sound, ② connecting a bellows pipe to keep the suction sound at a distance from the measuring point, ③ stopping the fan operation, ④ covering the engine with lead urethane, etc. The man-hours and cost involved in the study of contribution are a considerable burden on the development of a new machine.

- (2) Need for measurement data about existing machines

Predicting the dynamic noise level of a newly-developed machine requires not only results of studies of contributions to dynamic noise level of the individual components of existing machines but also the results of confirmation of the effects of measures taken with existing machines and various other types of data, including the drawings of existing machines. Actually, however, the measurement data that are needed are almost nonexistent. In many cases, therefore, it is necessary to newly obtain measurement data with an existing machine or recalculate using substitute data.

- (3) Consideration for differences between new and existing machines

A newly-developed machine differs from an existing machine in various respects – the outer panel thickness, engine speed, sound absorbing material application points, etc. Since the conventional method analyzes the dynamic noise level of an existing machine based on its specific conditions, the conditions of a newly-developed machine are not precisely reflected in the calculation.

- (4) Consideration for frequency range

The conventional noise prediction method focuses on the level of noise, leaving the frequency range of noise out of consideration. With this method, therefore, it is difficult to grasp the frequency range distribution of the sound source and determine effective sound absorbing materials and optimum outer panel thickness taking the frequency range into account.

3. Introduction of new noise prediction method

3.1 Features

The new noise prediction method calculates the dynamic noise level of a hydraulic excavator from bench test data about noise of its engine, muffler, and fan. It takes into account the transmission loss due to the engine hood, the absorption of sound by the sound absorbing material, and the attenuation of sound by distance. The salient features of the new method are as follows (Fig. 3).

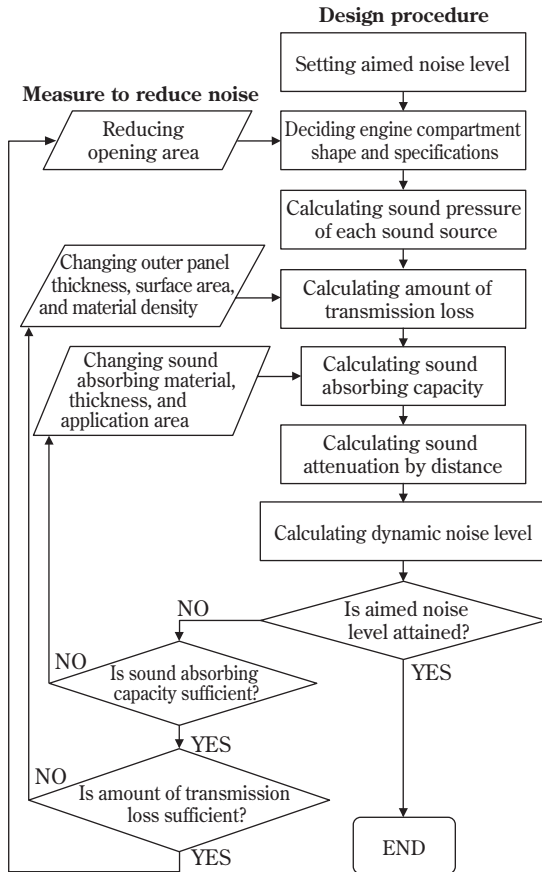

Fig. 3 Simulation flowchart

(1) Data about existing hydraulic excavators are unnecessary.

Since the new method uses the design data about a newly-developed hydraulic excavator to simulate its noise, it does not require data about existing hydraulic excavators obtained in the past, such as their design data or the contribution to noise of each individual component.

(2) Frequency range is taken into consideration.

Since the new method reflects even the frequency range of noise in the calculations, it permits analyzing the dynamic noise level in more detail.

(3) Ease of use.

Since the new method uses an EXCEL file for the calculations, it is possible to easily grasp the dynamic noise level of a hydraulic excavator or the effects of measures taken with the excavator anywhere. All it needs is a personal computer.

3.2 Premises

- (1) The engine compartment is a diffuse sound field.
- (2) The open air is a semi-free sound field.
- (3) The main sound sources are the engine, muffler, and fan.
- (4) The new method cannot be applied when analysis results are influenced by the directivity of sound.
- (5) The engine compartment is assumed as an enclosure (soundproof cover) (Fig. 4).

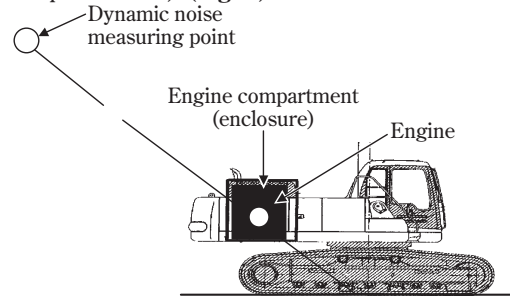

Fig. 4 Noise measuring point

3.3 Principal data used analysis

(All data about newly-developed hydraulic excavator)

- (1) Data about covering of engine room compartment
 - ① Material ② Thickness ③ Surface area
 - ④ Material density ⑤ Opening area
 - ⑥ Opening positions ⑦ External dimensions
 - (2) Characteristics of sound absorbing material
 - ① Material ② Thickness ③ Surface area
 - ④ Absorption coefficient
 - (3) Noise level around components
 - ① Engine sound ② Muffler sound ③ Fan sound
- (Results of 1/3 octave band analysis in frequency range 20 Hz to 20 kHz)

3.4 Main formulas used for calculations

The simulation by the new method is based on the combination the concepts of the following formulas for calculations and the analysis taking the frequency range into account (Fig. 5 and Fig. 6).

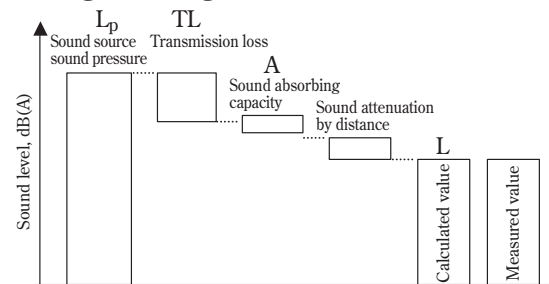

Fig. 5 Simulation process

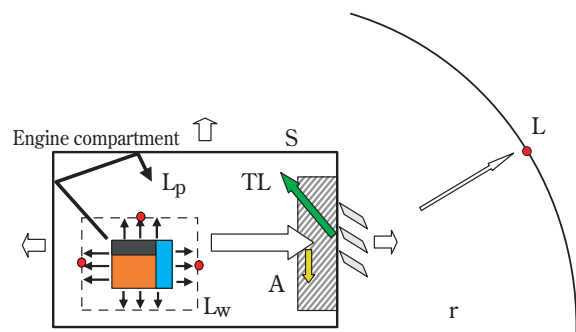

Fig. 6 Simulation scheme

(1) Outdoor noise of indoor sound source¹⁾

With the engine compartment and open air assumed to be indoor and outdoor, respectively, the concept of the following formula was reflected in the simulation. The fourth and fifth terms represent the sound attenuation by distance in a semi-free sound field.

The average absorption coefficient was obtained from relevant data supplied by the manufacturer of sound absorbing materials.

$$L = L_p - TL + 10\text{Log}(S/A) - 20\text{Log}(r) - 8 \dots\dots\dots 4)$$

$$TL = 10\text{Log}(\sum S_n / (\sum \tau_n \cdot S_n)) \dots\dots\dots 5)$$

$$A = \alpha \cdot S \dots\dots\dots 6)$$

- L_p : Sound pressure level of indoor sound source (dB)
- TL : Average transmission loss (dB)
- S : Total indoor surface area (m²)
- A : Indoor sound absorbing capacity (m²)
- r : Distance from wall surface to outdoor noise measuring point (m)
- α : Average indoor sound absorption coefficient
- S_n : Partial area (m²)
- τ_n : Partial transmittance

(2) Effect of enclosure²⁾

Assuming the engine compartment as an enclosure (soundproof cover), the concept of the following formula was adopted.

The third term in Equation 7) represents the amount of build-up (increase in sound pressure) due to the enclosure.

$$L_p = L_w = 10\text{Log}(1/S + 4/R) = L_w - 10\text{Log}(S) + 10\text{Log}[1 + 4(1 - \alpha)/\alpha] \dots\dots\dots 7)$$

$$R = \alpha S / (1 - \alpha) \dots\dots\dots 8)$$

- L_p : Sound pressure level at wall surface inside enclosure (dB)
- L_w : Acoustic power level of sound source (dB)
- S : Total surface area of enclosure interior (m²) (same as total indoor surface area shown above)
- α : Average enclosure sound absorption coefficient (same as average indoor sound absorption coefficient shown above)

R : Compartment constant of enclosure interior

(3) Transmission loss³⁾

Transmission loss is the ratio of intensity I_i of sound reaching the wall surface to intensity I_t of sound penetrating through the wall, that is, $10\text{Log}(I_i/I_t)$. In practice, transmission loss is calculated by the following equation (Table 1).

$$TL = 18\text{Log}(m \cdot f) - 44 \dots\dots\dots 9)$$

$$m = n \cdot t \dots\dots\dots 10)$$

- m : Surface density (kg/m²)
- n : Material density (kg/m³)
- t : Wall thickness (mm)
- f : Sound frequency (Hz)

Table 1 Transmission loss calculation sheet

Analysis of sound at entire surface of engine compartment

Center frequency	Transmission loss							
	TL'		τ'		$\tau \cdot S_n$			TL
	SPHC		SPHC		SS400P	SPHC	hole	Total A
t	1.6	3.2	1.6	3.2	3.2	1.6	—	—
S	—	—	—	—	2.42	3.88	2.59	9.50
20	-0.8	4.6	1.2E+00	3.5E-01	8.3E-01	4.7E+00	2.6E+00	0.7
8000	24.1	51.5	3.9E-03	7.2E-06	1.7E-05	1.5E-02	2.6E+00	5.6
10000	47.8	53.2	1.7E-05	4.8E-06	1.2E-05	6.5E-05	2.6E+00	5.6
12500	49.5	54.9	1.1E-05	3.2E-06	7.7E-06	4.3E-05	2.6E+00	5.6
16000	51.5	56.9	7.2E-06	2.1E-06	5.0E-06	2.8E-05	2.6E+00	5.6
20000	53.2	58.6	4.8E-06	1.4E-06	3.3E-06	1.9E-05	2.6E+00	5.6
APc	57.6	63.2	Transmission loss at coincidence frequency					
ic	8028	4014						
TLC	24.1	30.1						

(4) Coincidence effect²⁾

The coincidence effect is the decline in transmission loss caused by a phenomenon similar to the resonance between the incoming sound and the wall surface. The frequency at which this phenomenon occurs is called the coincidence frequency. It is known that at the coincidence frequency, the transmission loss is not as large as the law of mass indicates.

$$f_c = C^2 / (1.8 \times 10^{-3} \cdot C_L \cdot t) \dots\dots\dots 11)$$

- f_c : Coincidence frequency (Hz)
- C : Sound velocity (m/s)
- C_L : Longitudinal wave propagation speed (m/s) (5.0 × 10³ m/s for steel, 4.0 × 10³ m/s for concrete)
- t : Wall thickness (mm)

(5) Transmission loss at coincidence frequency⁴⁾

The transmission loss at the coincidence frequency was calculated by using the following equation to improve the accuracy of simulation.

$$TL_c = 40 - 20\text{Log}(10/t) \dots\dots\dots 12)$$

- TL_c : Transmission loss at coincidence frequency (dB)
- t : Wall thickness (mm)

4. Comparison with measured values

4.1 Prediction of dynamic noise level

The dynamic noise level of each of five different hydraulic excavators was predicted by using the calculation method described above, and the calculated values were compared with the measured values. With the exception of one model which showed a difference of 2.2 dB (A), we could predict the dynamic noise level of each of the other four models within a difference of 1 dB (A). For model C, by predicting its dynamic noise level before completion, we could recognize the need for suitable measures to reduce the noise level and thereby shorten the period of development (Fig. 7).

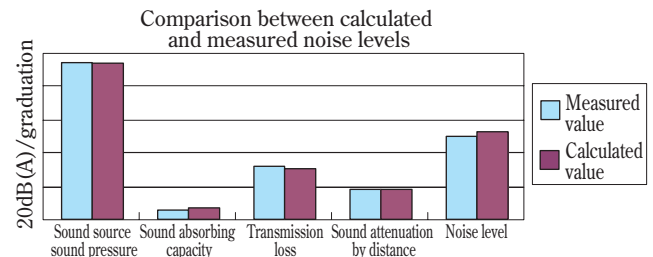

Fig. 7 Comparison between calculated and measured noise levels

4.2 Prediction of effects of measures taken

For model D, various measures to reduce its dynamic noise level were studied by using the new noise prediction method. As a result, we could judge the effects of those measures before they were taken.

(1) Planned measures to reduce dynamic noise level

- ① Blocking some of the openings in the hood
- ② Increasing the volume of sound absorbing material
- ③ Increasing the thickness of sound absorbing material
- ④ Lowering the engine speed

(2) Result of confirmation

An analysis by the new noise prediction method showed that planned measure ① would be the most effective of the four planned measures shown above. Therefore, we took that measure in order to confirm the accuracy of prediction.

(1) Content of measure taken:

Blocking some of the openings in the hood (The openings blocked are in the portion indicated by oblique lines in Fig. 8.)

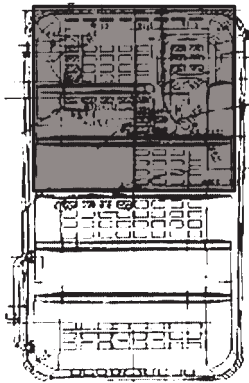

Fig. 8 Measure taken with the engine hood

(2) Result of confirmation

The predicted noise level was 72.2 dB (A) and the measured noise level was 71.9 dB (A). Thus, it was confirmed that the new noise prediction method could simulate even results of measures with a high degree of accuracy.

5. Implementation of experiment with model

With the aim of further improving the accuracy of simulation by the new noise prediction method and isolating problems in the method, we carried out an experiment using a model in a semi-anechoic room of Shiga Prefectural University (Fig. 9 and Fig. 10).



Fig. 9 Scene of experimentation with model (1)



Fig. 10 Scene of experimentation with model (2)

5.1 Conditions

Sound source	: YAMAHA MS60S
Specimen box	: 0.7m × 0.8m × 0.4m, SPHC t1.6
Semi-anechoic room	: 5.0m × 5.0m × 3.0m(H)
Noise produced	: Pink noise Generator: RION SA28
Noise meter	: RION precision noise meter NA27
Analyzer	: ONO SOKKI DS9000 Series

5.2 Method

Assuming the speaker as the engine and the specimen box as the engine compartment, their dimensions were made the same in proportion as a 15 ton class hydraulic excavator. The noise level around the specimen box was obtained from the noise level around the speaker. With the specimen box placed at the center of a virtual hemisphere in the test room, the dynamic noise level was measured by the method specified in ISO 3744 (1994) (calculation of acoustic power level of sound source by sound pressure method) to check the validity of the new noise prediction technique. The main methods used are shown below.

(1) Transmission loss

Sound pressure level was measured inside and outside the specimen box.

(2) Sound absorbing capacity

Sound pressure level inside the specimen box with and without the sound absorbing material (PET) was measured.

5.3 Results

In each calculation process, the difference between calculated and measured values, including those of noise level, was within 2 dB(A). It was found that the difference between calculated and measured values of transmission loss was the largest. In the future, it is necessary to carry out many experiments and formulate an experimental formula so that the new noise prediction technique can simulate the dynamic noise level more accurately (Fig. 11).

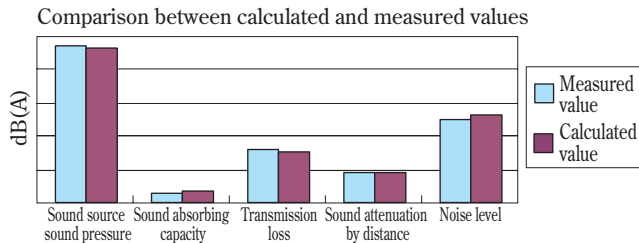

Fig. 11 Results of experiment with model

6. Conclusion

At present, the noise levels of almost all components of construction equipment are evaluated by sound pressure levels measured at several points of each of those components. In the future, we would like to improve the accuracy of calculation by the new noise prediction technique and shorten the period of development of new hydraulic excavators by grasping the level of their noise in terms of the acoustic power level and reflecting the value in the simulation by the new technique. I wish to express my heartfelt thanks to the people of Shiga Prefectural University for their generous cooperation in the verification experiment.

References

- 1) Antipollution Technology and Law (Noise Edition), Maruzen Co., Ltd., p. 133
- 2) Kazuhiro Shiraki: Prevention of Noise and Simulation, Oyogijutsu Shuppan Co., Ltd., p. 229
- 3) Acoustical Materials Association of Japan: Handbook on Measures against Noise and Vibration, Gihodo Shuppan Co., Ltd.
- 4) Watters B.G., J.Acou.SocAm.31(7)898-911, 1959

Introduction of the writer



Mikio Iwasaki

Entered Komatsu in 1993. Currently working in Test Engineering Center, Development Division, Komatsu.

[A few words from the writer]

The advances in the field of CAE are so fast that almost everything can be predicted fairly accurately on the drawing board. However, truth lies only in principles, rules, workshops, actual things, realities. I think that this must be remembered when making simulations of any kind.