

Introduction of Product

Development of PX500 Low-profile, Great-depth Clamshell

Satoru Nishimura

Takanori Hata

Under new concept KOMATSU developed PX500 Low-profile, Great-depth Clamshell, which is quite a new underground soil discharger with many advanced features for underground work in construction and civil engineering industries, etc., and brought it to the market, gaining a high reputation from users.

Key Words: *Underground Work, Construction Underground Work, Civil Engineering Underground Work, Underground Soil Discharger, Clamshell, Large-Scale Underground Earth Moving, Urban Redevelopment, New Model, Economic, Safety*

1. Introduction

In recent years, there has been a rising need for urban redevelopment to cope with an ever intensifying population concentration in urban areas. With this background, the Great Depth Underground Utilization Law was implemented in 2000. Under the new law, the use of underground areas deeper than 40 meters from the surface has been liberalized for public purposes.

Buildings are constructed higher and deeper, and underground spaces are being used more briskly for underground shopping malls, subway systems, underground water supplies and sewer systems, underground stockpile bases, underground water reservoirs for emergency, and many other purposes.

In this connection, we have conducted a survey to determine how machines are being used in civil engineering underground work. We have found that the most important task is how to dig, hoist, and discharge a large quantity of underground soil safely and economically. We have also

understood that existing machines have various problems as outlined in **Tables 1** and **2**. Accordingly, to solve these problems at a stroke, we have designed, developed and introduced to the market three (3) limited number machine units having the following features unavailable from other manufacturers for underground digging/discharging from a greater depth: ① Underground workability at a greater depth of 70 meters, ② Improved methods for construction underground work and civil engineering underground work, ③ Improved production over existing mainstream machines of the crawler crane type by 20% and over, ④ Operability with ease by a person with skills for operating a hydraulic excavator without requiring a crane operator's license, ⑤ Wholly transportable without disassembly ⑥ Drastically improved safety

These machines were highly evaluated by users on improvement of construction methods.



Photo 1 Appearance of the PX500 low-profile, great-depth clamshell

Table 1 Problems of existing methods and machines

Application	Work trends	Problems with existing methods and machines	
(1) Construction underground work Underground construction Underground parking lots	Mainstream is reversible construction methods	Portal type crane	* Moving is not easy because of fixed machine
		Crawler crane type clamshell (applicable for general purposes)	* Ceiling girders for 2nd and 3rd floors need to be removed to retain working space.
			* Must work safely because of narrow work site
			* Transportation without disassembly inhibited because of a long boom
			* Operating skills are necessary in addition to a crane operator's license, which prevents anyone from operating a machine unless an operator has operating skills and the license.
(2) Civil engineering underground work Subway systems, underground shopping malls, and underground stockpile bases (tanks, water reservoirs)	Greater need for one-lane work (enables daytime work)	Vertical belt conveyor (for deeper underground digging)	* Slow hoisting speed reduces production as the work site becomes deeper.
			* Since over front loading is impossible, two lanes are required for swing-loading
		Telescopic clamshell (for shallow work)	* Large production available irrespective of the depth but application is impractical except for large scale work because of the size of initial investment
			* Not applicable to work deeper than 25 m * Has no overload stop function and over front loading is not possible

Table 2 Comparison of features of machines under existing construction methods

	What PX500 aims at	Crawler crane type clamshell	Telescopic clamshell	Portal type crane	Vertical belt conveyor
Investment (machine + maintenance costs)	○ Small	○ Small	○ Small	○ Small	× Large
Production	○ Large	△ Medium	△ Medium	× Small	○ Large
Availability for greater depth	○ Down to 70 m	△ Down to about 40 m	× Down to 25m	△ Down to about 40 m	○ Optional
Loading on dump trucks	○ Easy	△ Requires skill	○ Easy	○ Easy	× Requires a loading machine
Site adaptability	○ Able to move and operate inside a building	△ Difficult to move and operate inside a building	△ Difficult to move and operate inside a building	× Limited	× Limited
Transportability	○ Transportation without disassembly	△ Disassembled transportation	△ Disassembled transportation	× Disassembled transportation	× Disassembled transportation
Production cost (yen/m ³)	○ Inexpensive	△ Medium	○ Inexpensive	○ Inexpensive	× Expensive
Current state	—	Mainstream machines for deeper than 20 m	Mainstream machines for depth up to 20 m	Only when the crawler crane type clamshell is not applicable	For extraordinary volume of earth moving

2. Aims of development

The machine was developed based on the following concept: namely, applicability to underground work at comparatively shallow depths to a depth of 40 m and deeper to where the Great Depth Underground Utilization Law applies; ability of a single unit of the machine to carry on work conventional methods failed to; improved workability through improvement of method; improved economy with drastic increase of production; ease of operation and improved safety.

- (1) Applicability to underground work at a greater depth
- (2) Capable of carrying on construction underground work and civil engineering underground work with a single unit of the machine
- (3) Improved production by 20% and over
- (4) Simple operation and no crane operator's license requirement
- (5) Transportable in assembled state
- (6) Sharp improvement on safety

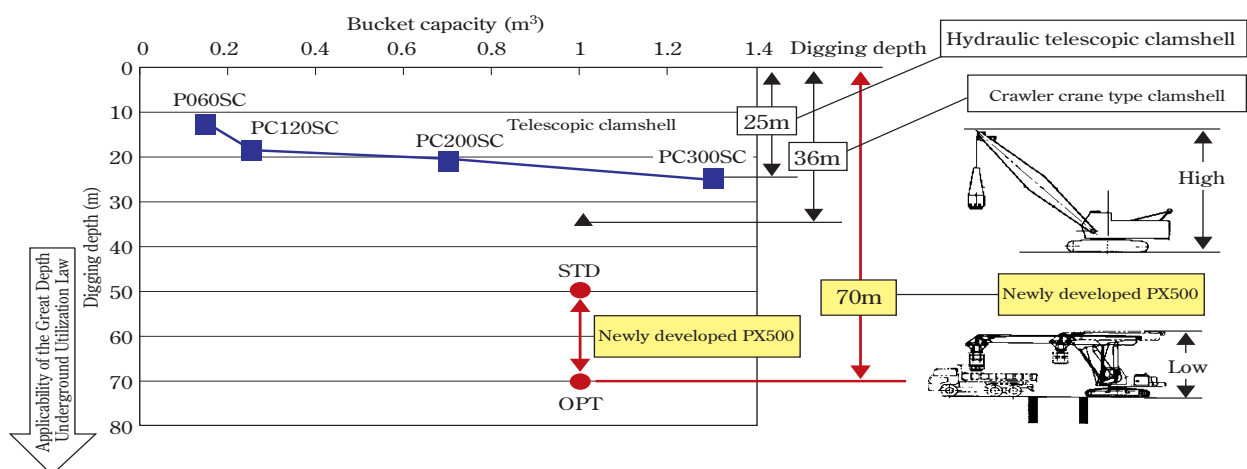

Fig. 1 Bucket capacity and digging depth of PX500 and existing machines

3. Main features

3-1 Applicability to underground work at a great depth (Fig. 1)

The current mainstream crawler crane type clamshell (Photo 2) is of the cable type. Therefore, it is often thought that the machine can be used for greater depths over 40 m by changing the cable. The bucket is held by the center with a cable each for hoisting/lowering and for opening/closing. To prevent the bucket from rotating with the rotation of the cable, cables with a “reverse direction of twist” to each other are used. However, if the load on each cable becomes mutually unbalanced, the bucket starts rotating continually, posing a risk of falling soil. To prevent this, a tug cable is attached but it becomes less effective as the depth increases. Moreover, the deeper the depth, the more the bucket sways. It may collide with the girder (underground steel frame) and increase the risk of falling soil. Accordingly, a certain manufacturer sets the maximum digging depth to 36 m and makes no recommendation for work at deeper depths. Although it is not impossible to carry on work at a lower depth by balancing the load on the two holding cables and minimizing swaying, it may take two years of skill training before the work becomes practical. Even in such a case, there may be a possible risk of the bucket rotating due to the operator’s minor error or the bucket colliding with the girders due to swaying.

(1) Four-cable suspension bucket (*patent pending)

A cross bracket is attached to the end of the work equipment. Two bucket hoist cables, each left and right and another two bucket open cables are hung from it with ample distance from each other. Adoption of this new structure that holds the bucket with 4 cables (Photo 3) enables digging and soil hoisting work 70 meters underground without allowing the bucket to rotate while minimizing swaying to a great extent. Unskilled operators can now operate safely.

And each two cables for hoisting and opening the bucket ensure safe work without falling soil, unstable buckets, collisions with the girder, etc. even if one cable is sheared.

(2) Installation of a winch for work 70 m underground (*patent pending)

The standard winch can work 50 m underground. By changing the cable, the winch can work 70 m underground. Also, the winch installed at the rearend of the upper structure functions as a counterweight, making the machine weight much lighter than the competitive crawler crane type and telescopic clamshells, realizing improved maneuverability and site adaptability (Photo 4). In addition, cable retaining rollers and guiding sheaves are installed to the rear of the winch to prevent stray winding of cable. (Photo 5)

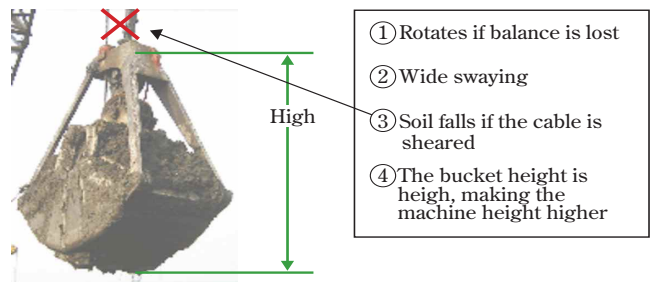

Photo 2 Crawler crane type clamshell bucket

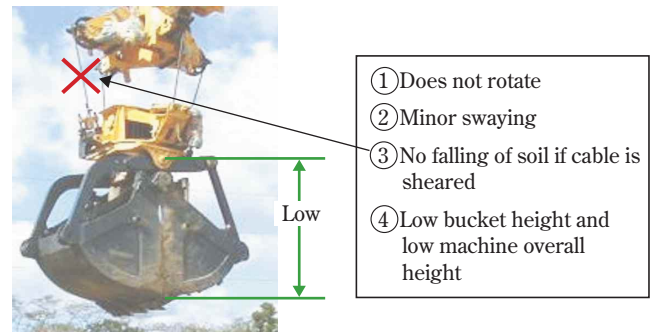

Photo 3 New linkage bucket for PX500



Photo 4 Appearance of PX500 from the rear

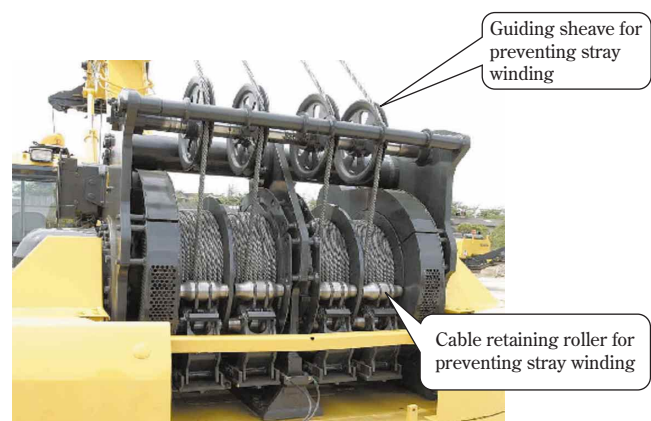

Photo 5 Winch and rollers for preventing stray winding

3-2 A single machine unit can cover construction underground work and civil engineering underground work

Existing underground soil hoisting machines are specifically separated for construction or civil engineering application (Table 1). Only the crawler crane type clamshell is applicable for both types of work but not without restrictive conditions as described in the following items:

(1) New type work equipment and bucket

New parallel linkage & slide arm work equipment and a new type bucket under a totally new concept have been adopted. Drastic improvement could be achieved by respectively changing conventional methods for civil engineering underground work.

① Improved method for construction underground work

In the case of the crawler crane type clamshell, the work equipment is approximately 10 meters high. When applying this machine to a reversible construction method (for simultaneously implementing ground and underground construction work to minimize the construction period—a method that has become mainstream recently), ceiling girders for the 2nd and 3rd floors are removed in advance, and upon completion of soil hoisting work from underground, either the ceiling girders are constructed or the space is designed as a wellhole type structure. The new work equipment could lower the overall height in action, allowing work without removal of the ceiling girders. This has eliminated restrictive conditions for construction. It can be effectively employed for the reversible construction method, saving money spent for construction. (Fig. 2)

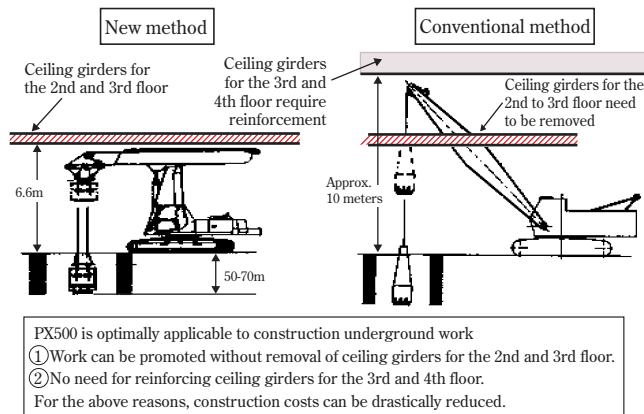

Fig. 2 Improved method for construction underground work

② Improved method for civil engineering underground work

In the case of subway system construction work, etc. in an urban redevelopment project, the subway is often constructed under surface roads. In such a case, soil hoisting machines are arranged on the road to discharge a large volume of soil from underground. With the crawler crane type clamshell, the swing-loading method is inevitably applied by fixing the boom of the work equipment. This occupies two lanes of the road for working space. And, to avoid disturbance to traffic, construction work is usually done only at midnight. This extends the construction period.

PX500 arranges a dump truck in front of the opening for over front loading by using work equipment with a new slide arm. This enables working within one lane and during the daytime to achieve a drastic reduction in the construction period and costs. (Fig. 3)

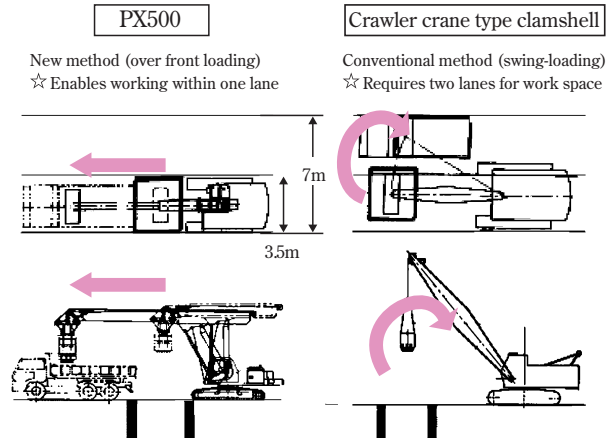

Fig. 3 Improved method for civil engineering underground work

3-3 Improves production by 20% and over

This new method has improved production by 20% or more at all work sites and at all ranges of depth over the mainstream crawler crane type clamshell for underground work at a depth of 20 meters or more.

(1) Adoption of high efficiency engine and hydraulic control system

Adoption of a high efficiency engine and hydraulic control system for hydraulic excavators with remarkably evolving functions achieved a soil hoisting speed approximately 1.5 times faster than that of the crawler crane type clamshell, realizing a production improvement of over 20% in total ranges of depth. As working depth increased, the difference became greater and a 25% improvement could be achieved at a depth of 50 meters. (Fig. 4)

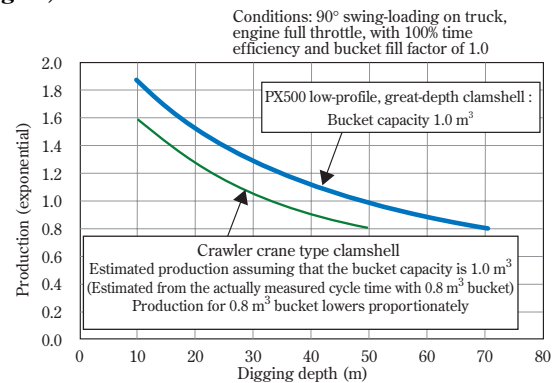

Fig. 4 Comparison of production

(2) New four-cable suspension bucket effective in narrow work sites

In the case of construction work inside a building or with a narrow opening to the underground, the crawler crane type clamshell is required to slow down working speed for safety to prevent bucket swaying as explained in 3-1. In the case of PX500, working speed need not be lowered as there is little swaying. (see 3-1(1))

3-4 Easy operation and no requirement for a crane operator's license

(1) Operation of crawler crane type clamshell

Depending on the crane, a crane operator's license is required. In addition, a number of operation levers are arranged in front of the operator's seat. The operator is required to operate five (5) levers and two (2) pedals during normal swing-loading. The operator is constantly required to change levers. The operation is complicated and requires a considerable number of days for a learner to get used to it. Furthermore, as the digging depth increases, the rotation and swaying of the bucket become greater as stated in 3-1. It is said that it takes at least two years before one attains sufficient skill for operation in construction work at great depth. (Fig. 5)

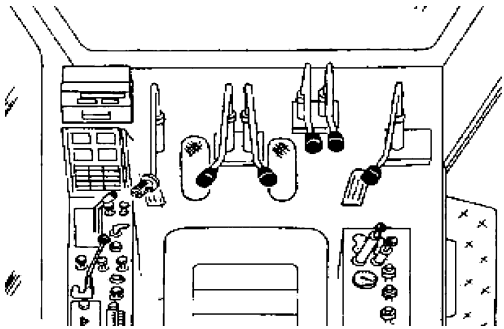

Fig. 5 Operator's compartment of a crawler crane type clamshell

(2) Operation of PX500

① Crane operator's license not required

Since PX500 is a machine used exclusively for digging and loading, no crane operator's license is required. This is identical with a hydraulic excavator and one can drive the machine after completing a course for specified operating skill learning.

② Streamlined lever arrangement based on a new operating system (*patent pending)

Operating levers are adopted from the hydraulic excavator whose operability has been remarkably improved. Operators can carry on normal operation by using only two levers as if operating a hydraulic excavator. If more work output is desired by reducing cycle time, the operator steps on the brake and clutch pedals to partially apply the brake while lowering the bucket. Then the lowering speed can be faster than the above by about three times. Accordingly, in the case of digging, hoisting and loading from a depth of 50 m for example, production can be increased about 1.4 times. In this case only operation of two (2) pedals is additionally required and the operator can work without releasing the hold on the operating levers. Adoption of this new operating system allows individuals to fully learn the operation within as early as a couple of days or within one week at the longest depending on individual differences. (Fig. 6)

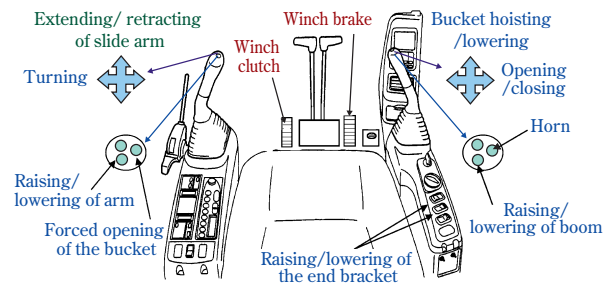

Fig. 6 Operator's compartment of PX500

3-5 Capable of transporting whole machine without disassembly

In the case of a crawler crane type clamshell, the boom and bucket have to be disassembled for transportation because of its heavy machine weight and long boom. In the case of PX500, transporting the whole machine without disassembly has become possible due to a rear located winch and new work equipment having a parallel linkage & slide arm. These have contributed to a light machine weight and easy pose for transportation. This can reduce the time and expenses for transportation. (Fig. 7)

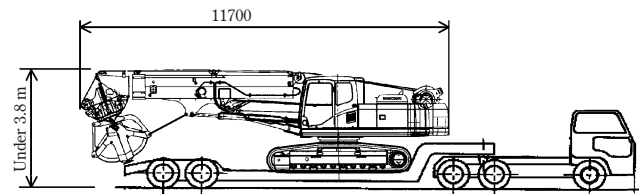

Fig. 7 PX500 pose for transportation (transportation without disassembly possible)

3-6 Improved safety

Safety is an important feature having priority over others. Since it is a major precondition in promoting the improvement of various other features, we have taken the following measures for improving safety:

- (1) Four-cable suspension bucket (3-1.(1))
 - ① Bucket does not rotate and sways little
 - ② Soil does not fall if a cable is sheared. The bucket remains stable held by three cables.
- (2) Two-winch synchronized control system (*patent pending)

Crawler crane type clamshell has one winch each for hoisting/lowering and opening/closing the bucket, which is held with a total of two cables from each winch. As stated in 3-1, the bucket starts rotating when the load balance between the two cables is lost during the hoisting/lowering of the bucket. Also, if the load on the bucket opening cable is reduced, the bucket opens up to let soil fall out. To prevent the loss of load balance and subsequent bucket rotation, the operator permanently applies a slightly greater load to the bucket-opening winch than to the bucket-hoisting winch. Thus the operator is required to make delicate adjustments by slightly advancing the operation of the bucket-opening lever when hoisting the bucket, and by slightly advancing the operation of the bucket-hoisting lever when lowering. Otherwise, the bucket may cause the risk of rotation or soil may fall out.

In this connection, a two-winch synchronized control system has been adopted for PX500 to always ensure safe work without depending on the skill of the operator. As shown in the hydraulic circuit diagram in Fig. 8, an interconnection circuit is provided from the outlet and inlet port to each winch motor. When hoisting the bucket, direction control valves for the interconnection circuit is actuated to interconnect the circuit. At the same time the main direction control valves for hoisting and opening open. When opening/closing the bucket, the interconnection circuit is disconnected and only the main direction control valve for opening/closing the bucket opens. In addition, the flow characteristics of the main direction control valve are set as shown in Fig. 9.

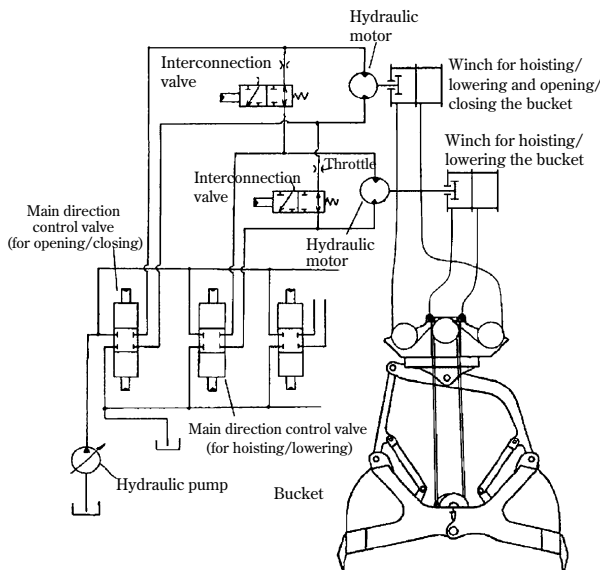

Fig. 8 Two-winch synchronized control

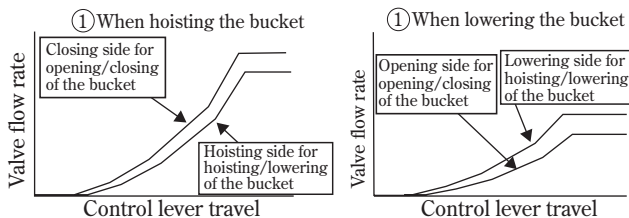

Fig. 9 Flow characteristics of the main direction control valve

This eliminates the need for the operator to make delicate adjustments. Even if some difference exists in the efficiency of respective motors for hoisting and opening the bucket, such a difference is compensated by the interconnection circuit. This prevents the bucket from opening during hoisting or lowering to let the soil fall out.

(3) Overload alarm and automatic stop system

This system detects and indicates the working range and the load on the monitor screen. When the working radius and the load respectively reach 95% of tolerance, a precaution alarm is displayed (overload is indicated in yellow on the monitor with the sounding of an intermittent buzzer) and the work equipment is decelerated. When 100% of tolerance is reached, a warning alarm is displayed (overload indicated in red on the

monitor with the uninterrupted sounding of the buzzer) and the work equipment stops immediately. Even if the work equipment stops, the levers are operable toward the safety side, however. (Photo 6, Fig. 10)



Photo 6 Monitor

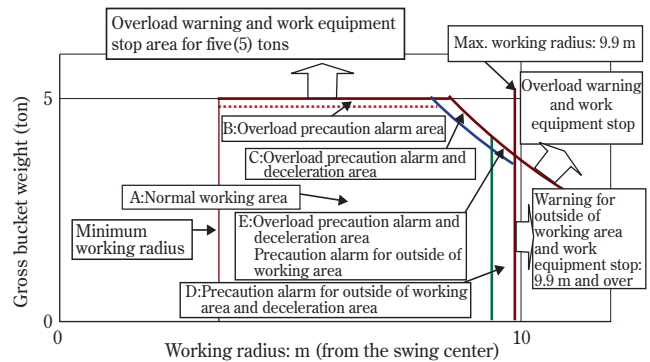

Fig. 10 PX500 overload stop control chart

(4) Bucket lowering speed warning system

The lowering of a bucket during normal operation is effected by power through control lever operation. When more production is desired by reducing the cycle time, the machine is designed to accelerate the lowering speed by applying a partial brake. In this case, should the lowering speed become over-accelerated, the warning lamp is lit and the buzzer is sounded to warn of danger when the lowering speed exceeds 250 m/min.

(5) Installation of the work equipment falling protection valves

If hoses on work equipment are bursted for any reason, there will be a danger of falling work equipment. To cope with it, a safety design was made to prevent falling by installing falling protection valves on the bottom sides of the boom cylinder and the parallel linkage cylinders.

3-7 Main specifications and comparison of the features

PX500 is a machine with the above-mentioned features. The machine will be compared with the crawler crane type clamshell and telescopic clamshell, which are mainly in use at present. (Table 3)

This table shows that PX500 is remarkably superior in each characteristic item.

Table 3 Comparison of PX500 features with competitive machines

○ :Better, △:slightly inferior, ×:inferior

Item			PX500	Conventional crawler crane type clamshell	Telescopic clamshell
Main spec.	Operating weight	t	29.8	38.6	41
	Bucket capacity	m ³	1.0(0.8)	1.0(0.8)	1.3
	Engine Flywheel horsepower	kW(PS)	125(170)	110(150)	173(235)
Applicability to work	Construction	Reversible construction method : overall height during the work	○ Operable within a girder height of 6.6 m	△ Operable within a girder height of 10m	× Inoperable within a girder height of 10m
	Civil engineering	Construction work under a one-lane road	○ Over front loading is enabled for the dump truck using a slide arm	× Over front loading is impossible due to the boom commonly used as a crane.	△ Over front loading is difficult
		Deep underground work	○ Standard machine can work down to 50 m max. Optionally the machine can work down to 70m max.	△ Max. down to 36 m with standard machine. Not recommendable for over 36 m.	× Down to 25 m max.
Safety	Sway and rotation of the bucket		○ Four-cable and cross hanging reduces swaying and eliminates bucket rotation	× Two cables holding the bucket at the center cause much swaying and rotation	○ Telescopic type reduces swaying and causes no bucket rotation
	Falling of the load when the cable is sheared		○ Double cable for opening /closing of the bucket prevents the load from falling	× Single cable for opening /closing of the bucket may cause falling of the load.	○ Double cable prevents falling
	Overload stop function		○ Function available	○ Function available	× Function not available
Workability	Production: 20 m/50 m depth	Ratio	○ 1.2/1.25	× 1.0/1.0	△ 1.4/Not applicable
	Ease of operation		○ Similar feeling to operating a hydraulic excavator	× A number of levers requiring skilled operation	○ Similar feeling to operating a hydraulic excavator
Transportability			○ Whole machine can be transported without disassembly	× Requires removal of the boom	× Requires removal of the arm

In each characteristic item, PX500 proves remarkably superior.

4. Operating records and their users' evaluation

Highly favorable evaluations were received from all purchaser-users of Machine Nos. 1 to 3 and their rental users (Table 4, Photo 7, Photo 8, Table 5)

Table 4 #10001 machine records of operation

	Service meter	Purpose of operation	Site of operation	Business type	Content of work	Depth in m
Field proving test	-300	Practical test	Test Engineering Center	—	Estimated construction and civil engineering work	20
	-405	First user	Tokyo	Civil engineering	Subway system	50
	-550	Second user	Nagoya	Construction	Building construction	8-10
Actual operation following	-1160	Actual operation following after sales	Tokyo	Construction	Building construction	15
	-1480		Osaka	Construction	Building construction	30
	-2200		Osaka	Civil engineering	Subway system	15-40
	-2270		Osaka	Civil engineering	Subway system	15-30
	-2410		Shiga	Lime stone quarry	Removal of rocks from hopper	70



Photo 7 PX500 in action at a construction underground work site



Photo 8 PX500 in action at a subway system construction work site

Table 5 User evaluation of PX500

High evaluation has been received from user companies regarding aims of the product.

Aims of the product		User evaluation
1	Workability at deep underground	Less bucket swaying and rotation at a depth of 50 m ensures operation with ease of mind.
2	Applicability to construction and civil engineering work	Optimal machine for reversible construction method that enables sharp reduction of expenses
	Civil engineering underground work	Possible over front loading and workability within one-lane are welcome features. Work conventionally done at night can be done during the day due to less traffic obstruction.
3	Production improved by over 20%	Faster bucket hoisting speed raises production by 20% with ease.
4	Easy operation and requires no crane operator's license	It is a very good point that one can operate the machine without a crane operator's license. It takes two years for people to master the skill of crane operation. They can get used to operating PX500 pretty soon. One week is enough for learning the operation.
5	Capable of transporting a whole machine without disassembly	Transportation without disassembly saves the operator from tedious work for shipping.
6	Drastic improvement of safety	Four-cable suspension eliminates the operator's worry about soil falling out if a cable is sheared.

5. On closing

We have developed and introduced PX500 to the market, a new low-profile, great-depth clamshell not conventionally available. Although only a limited number of users are operating this new machine at present, the machine could contribute to improving methods for construction underground work and civil engineering underground work. Favorable evaluations we received from users prove that our basic concept for development was right on track. This gives us great pleasure worth more than anything else in the world. In the future, we expect to receive various requests for further improvements in the stage of full-scale introduction to the market. We hope to raise the perfection level of the product by carefully following market needs and making further studies and quality improvement.

Introduction of the writers



Satoru Nishimura

Entered Komatsu in 1971
Currently belonging to the Hydraulic Excavator Development Group, Construction Equipment Technical Center 1, Development Division

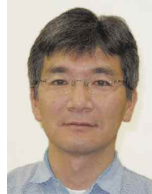

Takanori Hata

Entered Komatsu in 1991
Currently belonging to the Hydraulic Excavator Development Group, Construction Equipment Technical Center 1, Development Division

[A few words from the writers]

For us, the development of PX500 was an encounter with a unique machine incorporated with various functions completely different from the crawler crane type clamshell and other existing machines. We met numerous difficulties and problems in each phase of development because the subject item was to be a new product. We have successfully introduced the product to the market after solving those problems. We wish to acknowledge the cooperation and assistance received from individuals concerned, without which our development would have been either impossible or far less complete. We dream about the day when PX500, upon full-scale introduction to the market, is widely recognized for its superb performance in the field of construction underground work and civil engineering underground work, and used by our customers as "PX500 is the Project X500 of the Heisei period."