

## Introduction of Products

# Engine Powered Forklift Truck 1- to 3.5-ton Series “LEO NXT-V”

Hiroyuki Yamamoto  
Satoshi Takahara  
Makoto Saitou  
Motoshi Koizumi  
Tomohiro Shinotsuka

*The LEO NXT series has enjoyed a good reputation for reliability, technical innovation and good design (winners of 2002 Good Design Award by the Japanese Government and a grand prix of the 33<sup>rd</sup> Machine Industry Design Award). As a successor series of the LEO NXT for engine powered forklift trucks in the class of 1 to 3.5 tons, LEO NXT-V (Leo Next-V) has been developed by further refining the former series to improve earnings, in order to start production in Japan, the United States, Europe and China and to enter the global market representing the principal products of Komatsu Forklift Co. The model change is the first model change in ten years in the overseas market. An overview of the new series is presented below.*

**Key Words:** *Engine-type forklift, LEO NXT-V series, Compact 3.5 ton type, Power line float, Dual float design, Visibility, ISO 369-1 safety standard, Operator presence sensing (OPS) function, Komatsu Advanced Power Steering III, 3D-CAD*

## 1. Introduction

Interest in and demand for environmental friendliness and safety are mounting high for forklifts also throughout the world.

In the Japanese market also, about 50% of the motive power of forklifts has been changed from engines to batteries. However, the demand for engine forklifts is persistently strong because of their excellence in power, duration of operation, ease of operation, price and other factors, and engine forklifts are a major source of earnings for Komatsu. In this situation, the newly developed NXT-V series has accomplished these goals by: (1) A dual float system that holds the engine transmission unit and operator's seat separately for the first time for this class to reduce vibration and noise caused by the engine and to improve fuel consumption. (2) Compliance with ISO/DIS 3691-1 safety functions being amended, in advance. (3) Companywide simultaneous activities.

The machine model series consists of 38 models succeeding compact vehicles that are equal to the size of battery vehicles (Series 109: 1090 mm in vehicle width), fewer than the lineup of the previous model but adding compact 3.5-ton vehicles as a higher grade of the 2-ton models. The new series

made a debut in Japan and the market outside Japan almost simultaneously. Four typical types were sold: the 1 to 1.75 ton type, 2 to 3 ton type, 2-ton compact type and compact 3.5 ton type. Their full views are shown in Photos 1 to 4.

## 2. Development Objectives

- (1) Globalization products for markets in Japan, the United States, Europe and China through a unified concept for Japan and the international market.
- (2) Succession of the excellence of the conventional series LEO NXT that enjoyed a good reputation in the market and differentiation from the products of other manufacturers by incorporating new technologies.
  - 1) Less engine and vibration of travelling, maintaining efficient operation through the dual float design by the “operator's seat float” and “power line float” and “seat with suspension.”
  - 2) Enhanced front visibility through a new cross section of the rail.



Photo 1 1-ton series standard vehicle (AX)



Photo 2 2-ton series compact vehicle (BX109 series)



Photo 3 2-ton series standard vehicle (BX)



Photo 4 Compact 3.5-ton vehicle (BX)

- 3) Compliance with ISO/DIS 3691 “Safety functions of forklifts” being amended, in advance.
- (3) A cost reduction of 20% to enhance earning power to achieve quality excellence and to ensure price competitiveness in the market.

### 3. Machine Model Series

The new series has added compact 3.5-ton models, but has reduced the number of models in the NXT-V to 38 by integrating and discontinuing models that are produced in small quantities. Net, variations meeting user needs have increased (Table 1).

Table 1 List of model series and engines mounted

LEO NXT-V Model Series		AXSeries ( 1-ton series )					BXSeries ( 2-ton series )				
		Wheel base (mm)	0.9	1.0	1.35	1.5	1.75	Wheel base (mm)	2.0	2.5	3.0
Small special vehicle	Gasoline vehicle	1400	○	○	○	○	1650	×	×		
	Diesel vehicle		□	□	□	□					
Gasoline vehicle	Gasoline vehicle		○	○	○	○		●	●	◎	◎
	Diesel vehicle		▲	▲	▲	▲		■	■	■	◆
High output vehicle	Gasoline vehicle				●	●		◎	×		
	Diesel vehicle							◇	◇	Newly set	
Compact vehicle	Gasoline vehicle						1400	●	◎	◎	
	Diesel vehicle							■	■	■	

**Symbols**

(1) × : Model discontinued

(2) List of engines mounted

Gasoline	Designation	Piston displacement	Output KW [ps]	Gasoline	Designation	Piston displacement	Output KW [ps]
○	K15	1486	27 [ 37 ]	▲	4LB1	1499	23.5 [ 32 ]
●	K21	2065	34.5 [ 47 ]	□	4D92E	2659	34.5 [ 47 ]
◎	K25	2488	42.6 [ 58 ]	■	4D94LE	3052	46.3 [ 63 ]
				◇	4D98E	3318	53 [ 72 ]

### 4. Design of Appearances

A sharper, more powerful design could be obtained succeeding the basic design, but aiming at correspondoning of global production without lowering the appearance quality of the previous series (LEO NXT), which enjoys a good reputation.

### 5. Principal Features

#### 5.1 Lowering of vibration

Installation rate on forklifts due to operating environment considerations. Komatsu’s past series have achieved features by floating the operator’s seat, mainly to reduce vibration of travelling. The demand for lowering of vibration has further increased. The new series was differentiated from the products of the other manufacturers by a full-scale dual float for the first time in the industry for this class; this floats the engine and T/M to further reduce engine and mast vibration (Fig. 1).

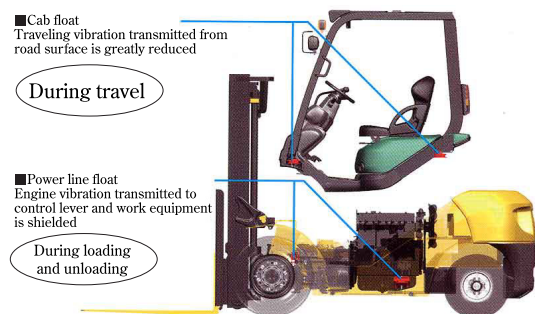

Fig. 1 Dual float



Photo 5 Design of vehicle exteriors

**(1) Power line float**

A 3-point mount system was achieved in realizing the mount featuring excellent vibration isolation and support rigidity unique to Komatsu forklifts that were achieved after repeating simulation by modal analysis (Fig. 2) and verifications using an actual advanced research vehicle (patents being applied for). In this system, the area near the center of the roll of the engine and transmission is firmly supported by one front mount to curb pitching and yawing in the vertical and horizontal directions (travel and swing), while supporting the soft rear mount to curb vibration in the roll direction (engine vibration). This offers the advantage of providing a space around the transmission (Fig. 3).

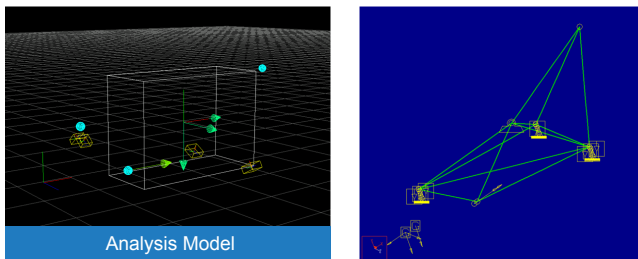

Fig. 2 Optimization analysis of mount

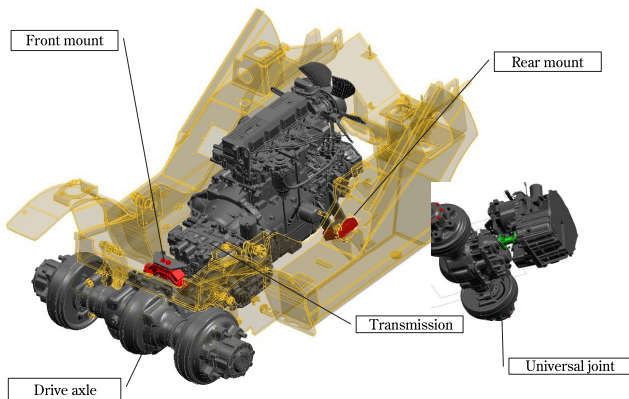

Fig. 3 Power line float

The reduction effects of steering wheel vibration and fork vibration in stationary operation through the use of this power line float are shown respectively in Figs. 4 and 5.

**(2) Cab float**

Following suit, in the cab mount that was modified in the LEO NXT series, the operator's seat was further improved to reduce vibration levels of travelling by 40% compared with the previous series (Fig. 6).

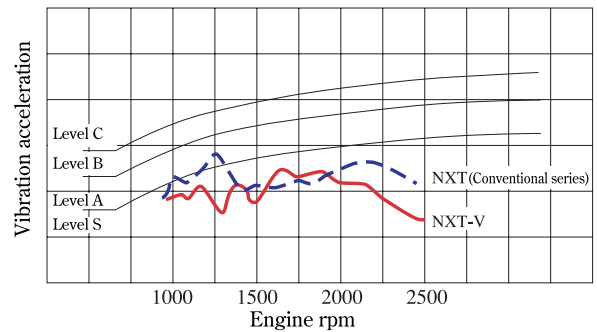

Fig. 4 Vibration of stationary steering wheel

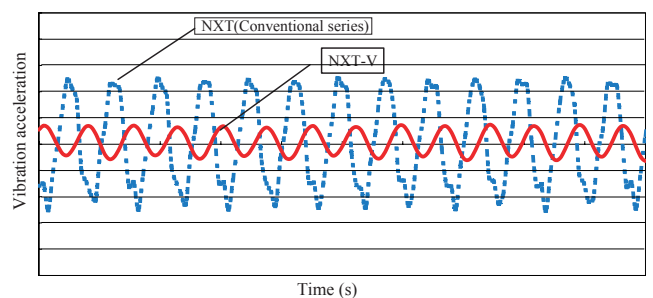

Fig. 5 Vibration of forklift

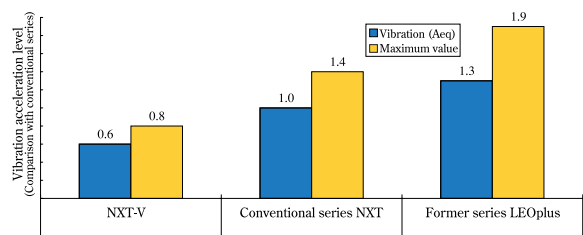

Fig. 6 Comparison of vibration level of travelling (By EN13059 vibration of travelling test mode)

**5.2 Power train**

Compared with the conventional backbone type, a universal joint was provided between the transmission and drive axle to prevent the propagation of engine vibration to the truck body, in order to lowering of vibration as mentioned above. This required a reduction in the total length of the transmission and drastic structural changes were made, such as to the longitudinal layout of the clutch pack. **Fig. 7** compares the construction of the conventional machine body and the new machine body.

By using an aluminum case and integrating the hub and drum, the overall cost reduction.

**5.3 Low noise**

Even though there were some obstacles to achieving low noise such as the covering on top of the operator head by a press-formed head guard, the aluminum transmission case and the increase in the airflow rate to reduce heat, the following was incorporated as a result of contributing analysis contributions to a prototype vehicle:

- (1) Optimization of cooling airflow
- (2) Noise shielding by tighter sealing of the engine room
- (3) Reduced air intake sound
- (4) Reduced a hydraulic pulsation

The level of noise near the operator’s ears could be reduced to as low as the levels of the products of other manufacturers.

Beginning the conventional series, air is suctioned into the engine through the rear leg of the head guard. The intake port is located behind the operator ears, contributing to noise near the operator’s ears. Noise by this air intake was reduced using a side branch of the air intake path (**Fig. 8**).

**5.4 Compliance with ISO/DIS 3691-1 safety standard (safety when leaving the operator’s seat) in advance**

ISO/DIS 3691-1 scheduled to be issued in 2007 requires shutting down the power, traveling and loading and unloading when the operator is not in the normal position for machine operation and control.

The NXT-V series has rapidly incorporated this operator presence sensing (OPS) function to implement additional safety functions in advance. The controller installed in the new series incorporates only the necessary and minimum functions to avoid system complexity and large cost increases. **Fig. 9** shows a system diagram of the OPS system functions and operations.

An operator frequently ease of getting on and off a forklift. Believing that easy getting on and off and enhanced comfortability of the vehicle to lessen operator fatigue and ensure safety, easy getting on and off has been further improved by increasing the foot space and providing large assist grips for ease of getting on and off, in addition to the improvements incorporated into the conventional LEO NXT series.

**5.5 Forward visibility**

Forward visibility is important for forklift operation, namely, loading, unloading and travel. A new cross section for mast rails has been developed to increase the inner width of the mast. (**Fig. 10**) An internal drain-type lift cylinder for low-pressure oil has been used, to eliminate the need for an oil return hose, which prevented good visibility. (**Fig. 11**) Compared with the conventional series, front visibility has been improved 6% with the 2-stage mast, and 14% with the 3-stage mast.

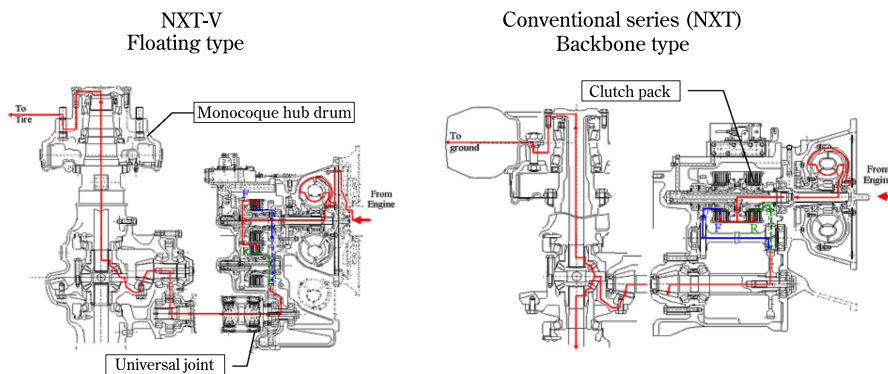

**Fig. 7** Comparison of power line structure

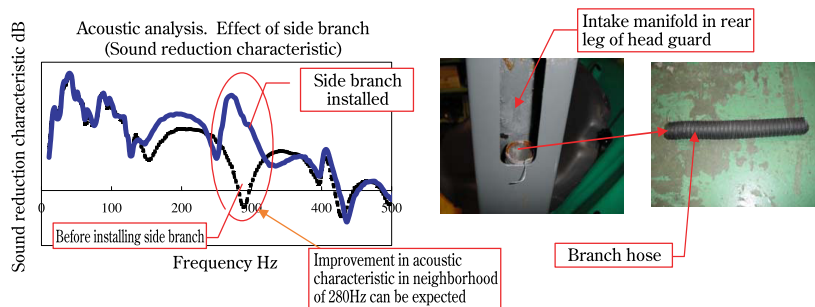

**Fig. 8** Example of reduction in intake sound



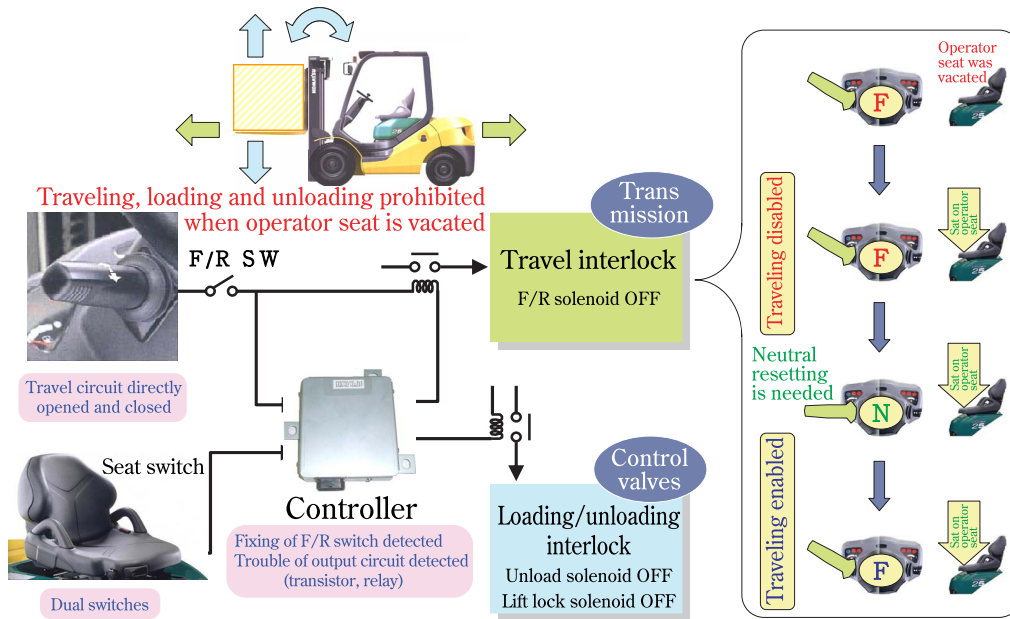

Fig. 9 OPS system

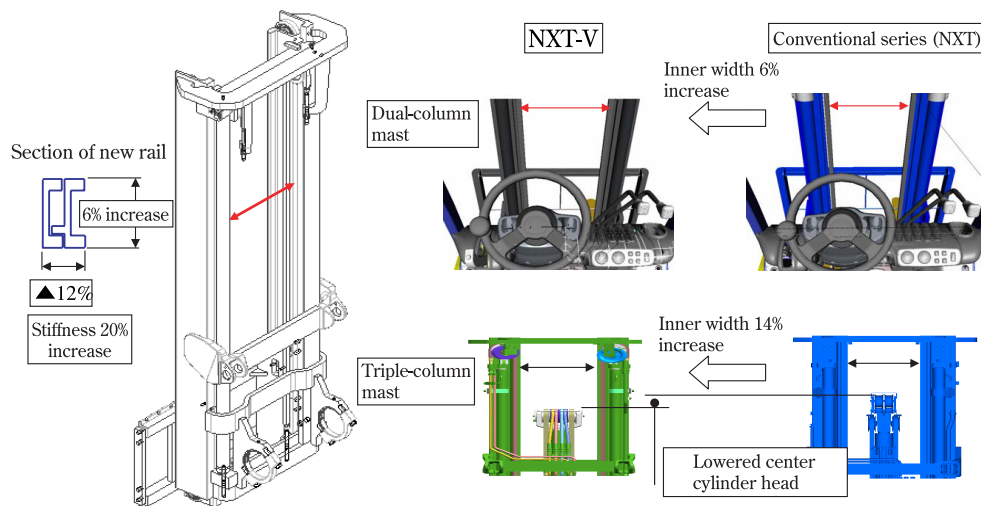
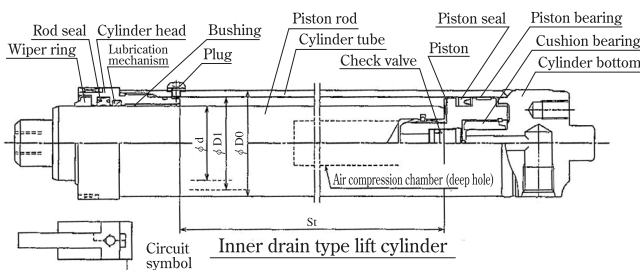

Fig. 10 Mast



Excerpt from Kayaba Technical Report No. 24, April, 2002

Fig. 11 Lift cylinder

### 5.6 Steering

The new series has discontinued the semi-integral system

of the closed type used in the conventional series and has adopted the full hydraulic power steering (FHPS) system. The mechanical link has been eliminated. This has enhanced sealing of the engine room, as well as maintainability and performance. To correct a “slip” between the steering wheel and tires caused by a leak inside the orbit roll, which is a weakness of the FHPS system, a function to correct “slips” has been provided by installing a dedicated controller. The new series can be operated as smoothly as the conventional series.

The correction method is the plus correction (flow regulating) system, KAPSIII (Komatsu Advanced Power Steering III), which gives the operator hardly any strange feeling when making corrections. Fig. 12, 13 and 14 compare the construction, function and performance of KAPSIII.

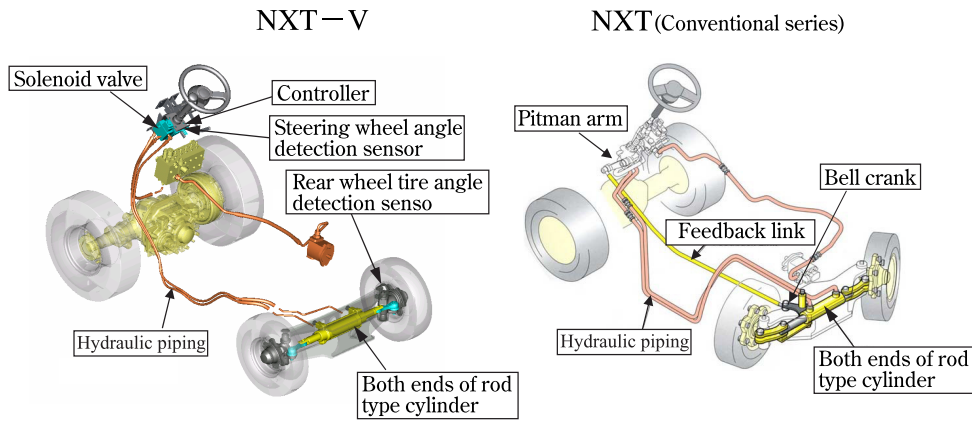

Fig. 12 Steering Structure

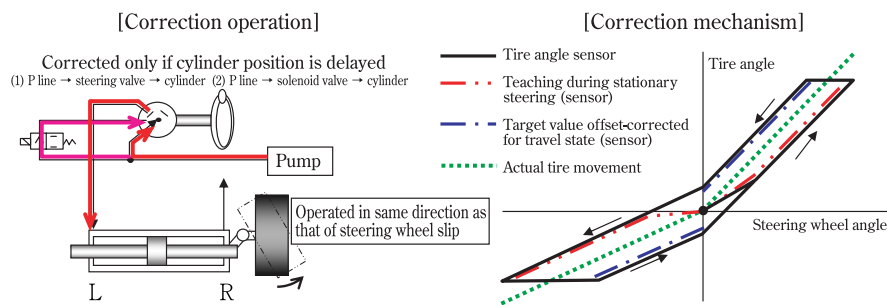

Fig. 13 Steering functions

Evaluation item and level comparison	NXT-V	NXT (Conventional series)
	KAPS III	KAPS II
Amount of steering wheel correction X: time s Y: Steering wheel revolutions rev		
Amount of forklift body meandering X: Wobbles (cycles) Y: Amount of wobbling in mm	 X=70, Y=70	 X=100, Y=100

Fig. 14 Comparison of steering performance

5.7 Reliability

(1) Heat balance

The heat balance has a tradeoff relationship with noise, product appearance and other elements and is a difficult theme to deal with. In the development of the new series, the air-flow in the engine room was analyzed by simulation, enabling early incorporation of improvement in weight opening and other parts. An example of the analysis models is shown in Fig. 15.

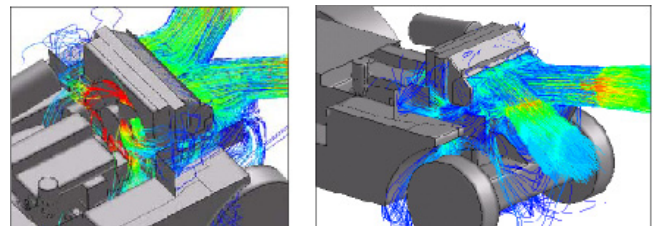

Fig. 15 Analysis of air flow inside room

### 6. Compact 3.5-ton vehicle

The efficiency of physical distribution is increasing year after year. The weight per pallet and work requiring carrying of pallets simultaneously are increasing. An increase in payload is demanded in narrow job sites where 3-ton-class vehicles operate and in the work of vehicles that mount attachments such as the roll clamps used by the papermaking industry because of large-sized cargo.

Vehicles of 3.5 tons are set in the high-output series (3.5- to 5-ton vehicles). However, to meet these demands of the market, a compact 3.5-ton vehicle has been added to the series.

The principal performance of this 3.5-ton vehicle is presented in **Table 2**. This vehicle has been set as a vehicle to efficiently and safely perform work even in a narrow job sites thanks to the compactness of the vehicle.

**Table 2** Principal specification of FD35A

	2-ton series base		4-ton series base
	FD30	FD35A	FD33
Machine model	FD30	FD35A	FD33
Maximum load (Kg)	3,000	3,500	3,250 (3,500)
Load center	500	500	600 (500)
Engine	4D98E(3.3L)		4.2L
Wheel base (mm)	1700	1700	1800
Overall width (mm)	1255	1290	1350
Swing radius (mm)	2370	2480	2530
Overall height (mm)	2090	2110	2150
Lift speed (mm/sec)	540	490	570
Vehicle speed (Km/H)	19.5	19.5	19.5

### 7. Cost Reduction Activities

This development project was undertaken as a company-wide activity as shown in **Table 3** to improve earnings, which was one of the development objectives. The net result of the activity was that the target was almost accomplished except external factors such as the price increase of steel, even though the initial target of reducing direct costs by 20% could not be attained. An improvement example is presented in **Fig. 16**.

**Table 3** Cost Reduction Activities

<Measure>	<Implemented Action>
① Initial activities by a project team staffed by members working full time and reporting directly to the president.	•New ideas and concepts created barrier free by young engineers free from fixed ideas.
② Project activities and collaborative development for power train in cooperation with Komatsu Transmission, drive axle	•Higher efficiency through activities by full-time resident members Collaborative work with body design
③ Reinforced development sector through assignment of simultaneous groups Through following up of pending matters for each theme Integrated activity of design and purchasing	•Greater effects by daily management of target accomplishment status and repeated discussions using goal accomplishment charts.
④ Quantitative effects through collaboration with Line Globalization→Synergy effect through joint efforts in Japan, USA, Europe and China	•Same components are used Engine, transmission, plastic parts, large press parts
⑤ Standardization and optimum design On the other hand ,parts and designs are not shared	•Strength members: Special design matching vehicle grade Frame, rear axle, Drive axle
⑥ Target setting based on information Automobile technology, joint development with vendors	•Progress management through productivity indicators •Productivity study with Komatsh Production Engineering Research Center •Use of state-of-the-art technologies,overhaul research of subcompact cars Monocoque hub, aluminum cases ST valve, operator seat
⑦ Conductive design work with plants and affiliated vendors Solution of problems under initiatives of production sector and integration of design	•Study of production process •Design that eliminates wastefulness Putty on weights eliminated, monocoque petal BKT

	NXT-V	Reduction rate	NXT(Conventional series)
Power train	<ul style="list-style-type: none"> <li>● Full float structure Eng-T/M floated by installing U/J</li> <li>● T/M commonly used to adopt aluminum case.</li> </ul> 	24%	<ul style="list-style-type: none"> <li>● Backbone structure Eng-T/M-front axle is built monocoque</li> </ul> 
Frame	<ul style="list-style-type: none"> <li>● Wheel pipe of power train is used as a reinforcement member</li> <li>● Spherical bushing eliminated.</li> <li>● Cross member in front of frame simplified.</li> </ul>  <ul style="list-style-type: none"> <li>● Outer plates made simple by bending</li> </ul>	24%	<ul style="list-style-type: none"> <li>● Reinforcement parts added to increase stiffness of forklift front part</li> </ul>  <ul style="list-style-type: none"> <li>● Press-formed outer plates</li> </ul>

Fig. 16 Examples of cost reductions achieved

### 8. Utilization of 3D CAD

Designed to establish a global development system and to strictly honor promised development periods, improvement in development efficiency was tackled by introducing various tools including 3D CAD, which was a core factor. The main improvement items and anticipated effects are as follows:

(1) Utilization of design review (DR) room

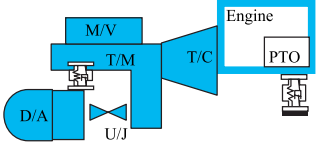
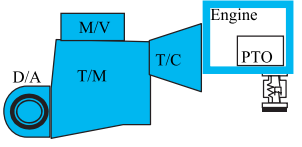
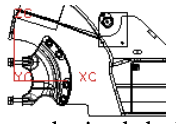
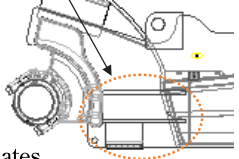
Utilizing a 3D screen, collaboration between the design and manufacturing departments was achieved. Problems were identified before issuing drawings for prototypes, to reduce corrective action items during prototype assembly to half compared with those of conventional series (Photo 6).



Photo 6 Design review through a 3D screen

(2) Manufacturing using simplified drawings and 3D data

Installation of viewer software within the Komatsu Group and affiliated suppliers was promoted. Those affiliated suppliers that were not implementing 3D CAD could make preliminary studies using the viewer software.

(3) Higher inspection efficiency using 3D data and 3D measuring apparatus

The collation of measurement data of contact free 3D measuring apparatus and 3D-CAD data upgraded the inspection accuracy of resin and stamping parts and reduced the number of man-hours (Photo 7).

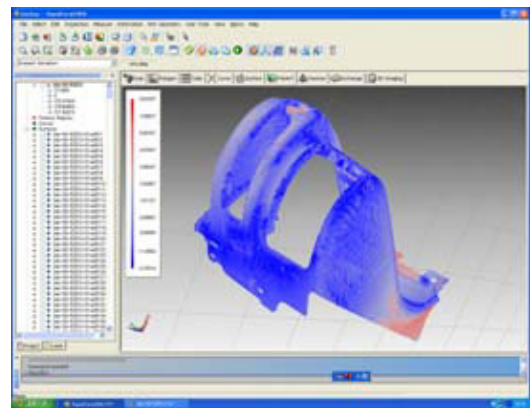

Photo 7 Verification through a contactless 3D measuring apparatus

### 9. Conclusion

Based on the LEO NXT series that was sold on the Japanese market in 2002 and that enjoyed a good reputation, the new NXT-V series with further improved comfortability and simultaneous introduction into the global market will soon mark one year since its first market entry. The new series is evaluated in the market for low-vibration performance, which was one of the objectives for development. Environmental problems are attracting the attention of the public, and emission control is becoming increasingly strict.

Perceiving that the realization of vehicles that are envi-



ronmentally clean, that achieve low noise and vibration and that consume less fuel is a mission assigned to us as engine-type forklift developers, our aspiration is to undertake activities based on the principle of “customer first.”

#### Introduction of the writers



**Hiroyuki Yamamoto**

Entered Komatsu Forklift Co., Ltd. in 1981  
Currently belongs to Custom-made Design  
Department/R&D Division



**Satoshi Takahara**

Entered Komatsu Forklift Co., Ltd. in 1991  
Currently belongs to Custom-made Design  
Department/R&D Division



**Makoto Saitou**

Entered Komatsu Forklift Co., Ltd. in 1991  
Currently belongs to Custom-made Design  
Department/R&D Division



**Motoshi Koizumi**

Entered Komatsu in 1993  
Currently belongs to Custom-made Design  
Department/R&D Division



**Tomohiro Shinotsuka**

Entered Komatsu Forklift Co., Ltd. in 2002  
Currently belongs to Custom-made Design  
Department/R&D Division

#### [A few words from the writers]

The world today is full of mobile videophones and walking robots that we could imagine only in SF comic stories when we were children. But how about forklifts? Sad to say, forklifts are still the direct driven type with a mast, forks and a weight. The basic structure has not changed. I would like to take time to consider the design of a forklift that has no mast.