

Technical Paper

Research and Development of Low-noise Bucket for Construction Machinery

Kuniaki Nakada

Kazuya Imamura

Mitsuo Yabe

As a result of the increasingly stricter regulations, noise emissions from construction machinery reduced, but the measurement required is made under controlled conditions and sound really made at actual job sites has been excluded from those regulations. A bucket for instance, however, would make a highest level of sound when hitting rocks and dirt some times if not so often and residents living in the vicinity would complain about it. Although there has been a strong customer need, reducing the bucket-making noise was practically difficult. Komatsu now offers buckets with new durable steel laminated dampers, which allows reducing noise 5dB(A) from the current level. This series of buckets is named "3Q Bucket" for use on hydraulic excavators and wheel loaders. The background of the development and technical features of the bucket are described below.

Key Words: *Environmental noise, low-noise bucket, wheel loader, hydraulic excavator, damping material, multilayer plate damper, noise regulation, noise complaints*

1. Introduction

Construction machinery has many noise sources such as hydraulic device installed with high horsepower engines, and operating work equipment and transmission device that operates the undercarriage. Because of the high contribution level of motive power source noise that is always generated, noise regulations are enforced by fully rotating the engine, which is the motive power source, in a stationary mode. The noise of motive power sources has been reduced through sound-source measures such as noise isolation of the machine room and sound-source measures for the exhaust and air intake silencers.¹⁾⁻³⁾

As a process condition that causes problems as noise sources in environmental noise regulations, dynamic conditions (simulated work cycles) are set for each model and require measurement at six stationary points on the surfaces of a virtual hemisphere to reduce noise in all directions (**Fig. 1**).

For the designation of low noise construction machinery, the Ministry of Land, Infrastructure and Transport of Japan, and EU set regulatory values proportional to the horsepower of the engine installed versus the power level converted from the measured values of these six locations. However, these conditions are for simulated work, and conditions for actual work

to handle earth, sand and rocks are not specified. Additionally, the development of low noise work equipment such as buckets and blades that can withstand rough contact and shock conditions is technically difficult. Under these circumstances, reduction in maximum noise (work noise) that does not occur frequently, but occurs during actual work when work equipment crashes and contacts objects, is not conducted.

According to environmental noise pollution surveyed by the Environmental Management Bureau of the Ministry of Environment and announced in December 2004, noise is always the top complaint item among seven typical environmental pollutions (air pollution, water pollution, soil contamination, vibration, noise, ground subsidence and offensive odor). Noise caused during construction work ranks second following noise emitted by factories and other business establishments. Noise complaints concentrate in five metropolis and prefectures (urban areas) of Japan (**Fig. 2, Table 1**). Low noise construction machinery for urban area is immediately needed.

Against this backdrop and triggered by the desire to develop a low noise technology that makes those users who are troubled by noise be thankful to Komatsu, the efforts focused on the bucket that clearly generates significant noise. As a

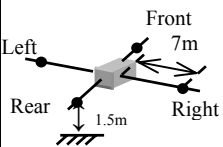
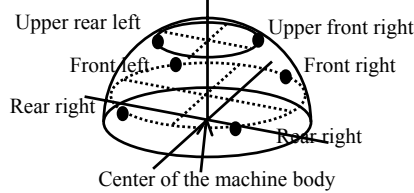
Year	1989	1997	2002
	Regulation by Germany and France	EU directive (Statistic)	EU directive (Dynamic) New EU directive
Objective	Low noise of engine system, which is the main source of noise		Stricter regulation, taking dispersions into consideration
Operating conditions	High idling engine speed under stationary condition		Conditions simulating work cycles
Control points	7m in front and rear and left and right from machine body side. Height 1.5m 	6 three dimensional points in the hemisphere surrounding the machine body 	

Fig. 1 History of EU noise regulations

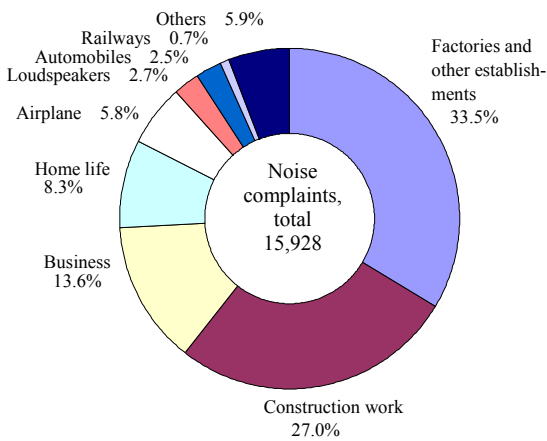


Fig. 2 Breakdown of complaints about noise

Table 1 Complaints received classified by area (Top five noise complaint areas)

Rank	Complaints		Rank	Complaints per million of population	
	Metropolis and prefectures	Complaints		Metropolis and prefectures	Complaints
1	Tokyo Metropolis	3,628	1	Tokyo Metropolis	300
2	Osaka Prefecture	1,625	2	Aichi Prefecture	201
3	Aichi Prefecture	1,415	3	Osaka Prefecture	188
4	Kanagawa Prefecture	1,296	4	Saitama Prefecture	172
5	Saitama Prefecture	1,119	5	Okinawa Prefecture	154
Total for Japan		15,928	Average for Japan		126

result, a low noise level that was not feasible in the past and that no other manufacturers in the industry have undertaken could be achieved. A low noise bucket for hydraulic excavators and wheel loaders that are mainly used in urban areas where excavation work is executed next to residential houses has been developed as reported below.

2. Research and Development Concept

R&D requires the setting of three targets, Q (quality), C (cost) and D (duration). The targets were set from the user's perspective.

Q: Low noise and fewer complaints = Effect is discernible to all

-5 dB (A) (Noise level lowered to 1/3. Fig. 3)

C: Low running cost (Durable)

(1) Durability equal to or better than that of standard products

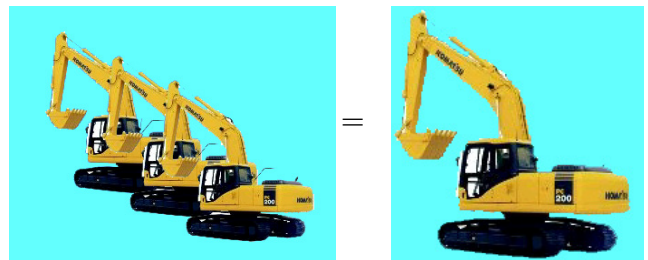
(2) No degradation in low noise quality

D: Shorter work duration for work during the night and near residential houses

(1) Full operation free from worries about noise complaints

(2) No limitation on workability (Weight increase less than 10%)

Wishing to develop a bucket for which users would be thankful to Komatsu for achieving the Q, C and D (Fig. 4), the bucket was named the "3Q (thank you) bucket" (Registered trademark No. 4879566).



Noise by three low-noise buckets

Noise of one STD bucket

Fig. 3 Noise target for low-noise bucket

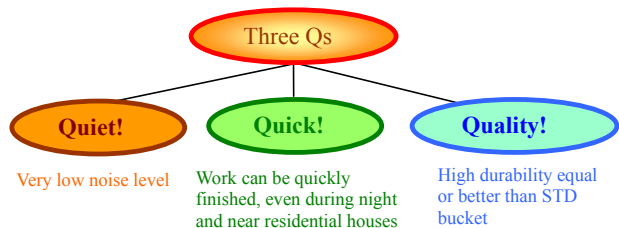


Fig. 4 3Q bucket

3. Problems for Low noise Bucket and Solutions

3.1 Mechanism of work noise generation

An example of work noise with the hydraulic excavator is shown in Fig. 5. Among the various components, the bucket generates the most noise. Noise is generated when the various parts of the bucket vibrate and emit noise through the force of the bucket crashing the earth, sand and rocks, making contact, dragging on a concrete surface and gravel, activating and pausing. Curbing of vibration from areas that emit large vibration radiation sounds is necessary, and a damping material is effective in reducing noise.

Figure 6 illustrates principal damping materials and their structures. The characteristics of these damping materials are described below.

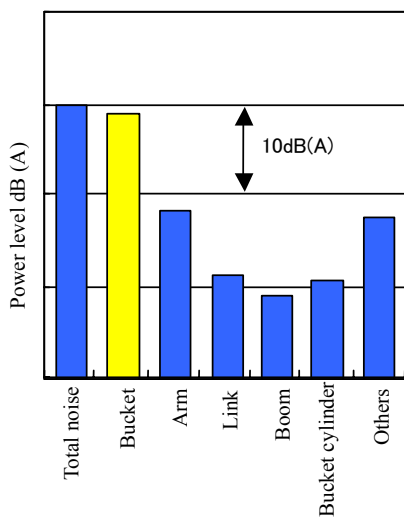


Fig. 5 Contribution of hydraulic excavator to work noise

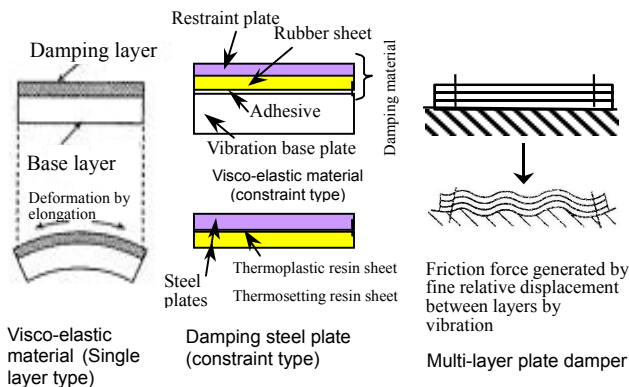


Fig. 6 Principal damping materials and constructions

3.2 Conventional damping technologies and their problems

In the past, damping materials mainly used visco-elastic materials such as rubber, resins and asphalt. These materials have been used in a single layer or by constraining them.

The single-layer type requires lining a component with a damping material component to counteract damp vibration that is easy to work on. However, one problem is that it is

removed or worn out easily when used for work equipment of construction machinery that is in direct contact with earth, sand and rocks. Sufficient results cannot be obtained unless a damping material that is twice or three times thicker than the base metal is used. Therefore, damping materials of the single-layer type are not suitable for construction machinery with thick components.

Wear resistance of the constraint type is high because its damping material is protected by a restraint material. As an additional feature, the damping mechanism by shear deformation of a visco-elastic material is used so that a high effect can be obtained using a thin damping material compared with the single-layer type. However, performance deterioration by heat and burning out are problems of visco-elastic materials. Visco-elastic materials thus could not be used in construction machinery that frequently undergoes repair by welding.

Damping steel plates that sandwich a thin resin layer by steel plates are also a kind of the constraint type.

The problems of conventional damping technologies are summarized as follows.

- ① No durability
 - No resistance to wear
 - Performance deterioration by heat and burning out
- ② Sufficiently high performance cannot be expected with thick plate structures.

3.3 Multi-layer damper

The multi-layer damper is made of steel plates only and has no durability problems, demonstrating good damping performance with thick steel plates that are used in construction machinery.

The multi-layer damper with lamination of the steel plates is a type of friction damper as in the leaf spring. When the base metal vibrates, the overlaid steel plates also vibrate and absorb vibration energy, which causes noise due to the friction force generated by fine relative displacement between the layers. Because the multi-layer damper is made of only steel plates, it excels in recycling performance, in addition to material strength, resistance to wear and the weather, compared with the visco-elastic materials mentioned above. The multi-layer damper can be mounted easily on buckets, which are steel-plate structures, by welding and other methods. It has excellent features as a damping device for construction machinery such as low cost, high durability and ease of repair.

4. Development of a Low noise Bucket

4.1 Analysis of vibration mode and selection of measures for low noise

In achieving a low noise bucket, it is important to curb the vibration that causes noise. As mentioned, multi-layer dampers are suitable for construction machinery among damping devices. However, improvement of bucket rigidity is also effective. The key technologies in developing a low noise bucket are improvement of bucket rigidity and where it can be used.

Generally speaking, it is effective to take action on the center of the vibration, where the amplitude is large; the first step in development is how the bucket as the object of development vibrates.

Structures have specific frequencies that cause resonance (natural frequency) and the mode of free vibration in a natural frequency is always the same. Reliable, effective measures and positions can be decided if this frequency and vibration mode (natural mode) are known.

An FEM simulation is also performed in analyzing vibration modes. Vibration mode analysis was conducted by experiments in the development work.

The bucket was hit using a hammer in which was embedded a load cell, called an impact hammer. Vibration accelerations at various parts of the bucket at this time were measured. Dividing acceleration at each part of the bucket by the impact force obtains transfer function H between the points of measurement that were hit as follows:

$$H = A/F$$

where A: vibration acceleration at point of measurement
 F: hit force obtained by load cell

The natural vibration mode was calculated from a theoretical formula using this transfer function. However, there were innumerable natural modes, and countermeasures and positions were decided by obtaining the natural vibration modes in the frequency region that caused noise problems.

(1) Bucket of hydraulic excavator

In the standard bucket, the side plates and rear and front parts of the bottom plate underwent the vibration mode that contributed to noise vibration resulting in noise radiation. Noise vibration was curbed as follows (Fig. 7).

- ① The rear bottom plate was reinforced using strip plates
- ② The front parts of the bottom plate depended on the torsional rigidity of the bottom plate, and the corners of the front parts were reinforced.
- ③ Multi-layer dampers were added onto all the surfaces against side vibration.

The results of these measures are shown in Fig. 8. The peak vibration was significantly reduced as the comparison of the vibration modes in Fig. 8 shows.

(2) Bucket for wheel loader

Based on the analysis of vibration modes shown in Fig. 9,

- ① A monocoque multi-layer plate was added onto all the surfaces of the side plates with large amplitude.
- ② The rigidity of the spill guard, to which large torsional vibration was applied, was reinforced in structure. A multi-layer plate was then added.
- ③ The bottom plate mainly had vibration modes of a higher mode and many centers of vibration. Small multi-layer plates were dispersedly added to the bottom plate to achieve an optimum low noise structure (Fig. 10).

4.2 Parameters for low noise design of multi-layer damper

The multi-layer damper demonstrates its damping effect using a friction force that is generated by displacement between layers. Therefore, the plate configuration (thickness and number of plates), as well as the mounting method (welding method and constraint points), decide the low noise effect.

Databasing of design parameters to allow use of multi-layer dampers to other devices shows the following.

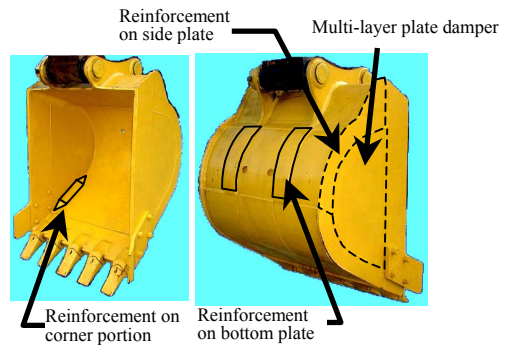


Fig. 7 3Q bucket of hydraulic excavator

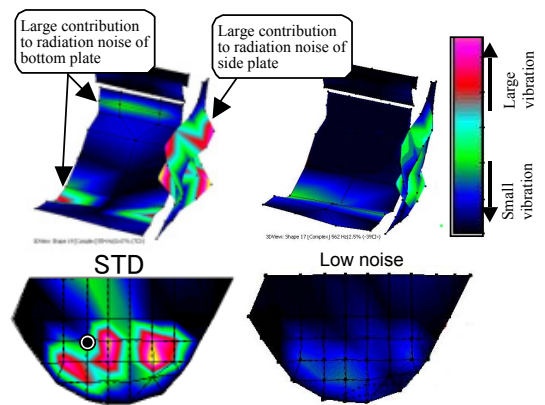


Fig. 8 Analysis result of vibration mode of hydraulic excavator

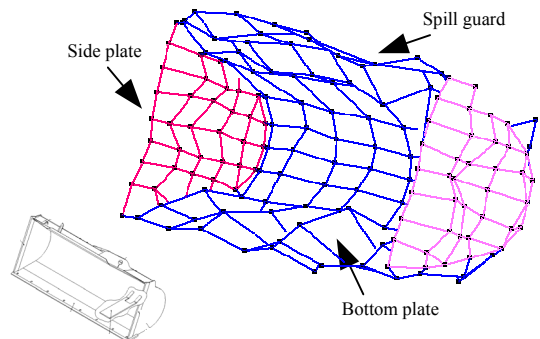


Fig. 9 Analysis result of wheel loader vibration mode

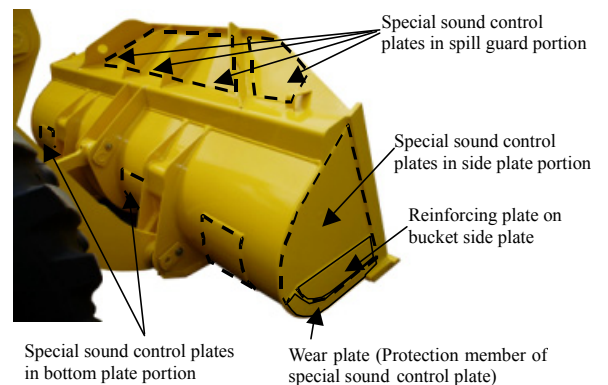


Fig. 10 Structure of low-noise bucket

- ① The larger the number of inner plates, the greater the effect.
- ② The fewer the constraint points (bolts and welded areas), the greater the effect.
- ③ Constraint points do not deteriorate the sound control effect if they are located in the nodal positions of the vibration modes.
- ④ The thickness of the outer plates has an optimum value commensurate with the rigidity of the object.
- ⑤ A larger press force is better, and a collar needs be provided in bolting.
- ⑥ A larger area is better, but dampers need be mounted dispersedly if vibration modes of a higher mode are the main modes.

The relationship between the noise reduction effect and sensory evaluation obtained in this level test (Fig. 11) has verified that -5 dB (A), which was the R&D target, would be the reduction quantity discernible to all who were exposed to noise.

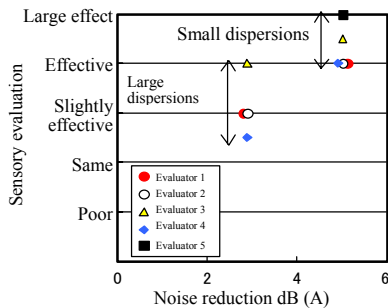


Fig. 11 Noise reduction versus evaluation values

4.3 Merchandising low noise bucket

The low noise bucket commonly uses the standard bucket, which has been proven excellent in quality, as well as structure and components. Multi-layer dampers add the following features in their manufacturing process.

- ① Special sound control structure

Made of steel plates only, the surface of the damper is lined with high-tensile steel plates that excel in wear resistance.

The layer plates are plug welded near the nodes of the vibration modes to fix the plates, sound control structure of high durability is achieved with both an excellent sound control effect and appearance quality through adherence between the layers and the prevention of rising of the outer plates.

- ② Protection structure of multi-layer plates

Areas around the ends of multi-layer plates are protected by other components or by adding a wear plate to prevent them from being directly exposed to earth, sand and other materials. Areas around the multi-layer plates are welded all around to prevent freezing or rusting due to the ingress of rainwater into the areas between the layers.

- ③ Rugged design for hard jobsites

Reinforcing plates that do not obstruct the sound control effect of the multi-layer dampers are added onto components that abrade the bucket and wear out more easily.

Low noise buckets are operated more in urban areas, and further lowering of noise is desired. The following two models were merchandised first.

- ① For hydraulic excavator

Dubbed the “Quiet 3Q Bucket,” this bucket has been merchandised as a new-function bucket that is Komatsu’s original for 20-ton-class hydraulic excavators with a standard bucket capacity of 0.8 m³ (conforming to Komatsu model PC200-8, engine output 110 kW). The bucket is sold as an option supplied by the stores.

- ② For wheel loader

Dubbed “URBAN SILENCER” (Fig. 12), the bucket has been merchandised for small models with a heaping capacity of 1.3 m³ (conforming to Komatsu model WA100, engine output 68 kW). The vehicle body is thoroughly made to emit low noise, mounting a low noise bucket as a standard specification⁴⁾ on the WA100 super low noise construction machinery approved by the Ministry of Land, Infrastructure and Transport of Japan.

4.4 Low noise effect

Prior to merchandising low noise buckets, prototype buckets have been test-used by users for certain periods and

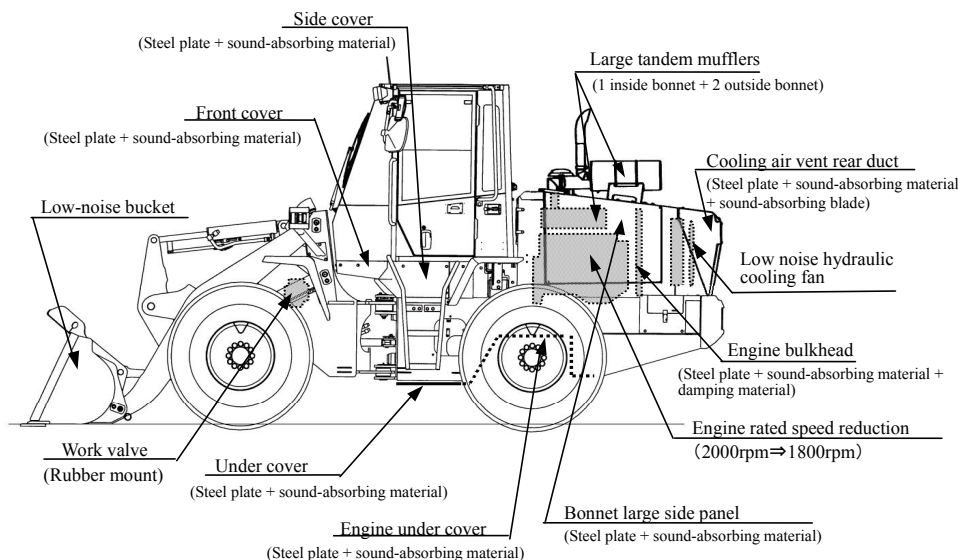


Fig. 12 Low noise structure of URBAN SILENCER

have received a high evaluation as follows.

- The low noise bucket emits only a dull sound, but does not vibrate.
- The sound of the bucket during operation is entirely acceptable. (High-pitched sound is not emitted but it is quiet.)
- There is a wish to mount a low noise bucket.

The reduction effects of noise in actual operation measured with actual machines are plotted in **Figs. 13** and **14**. A noise reduction of 5 dB (A) was accomplished with a bucket skeleton of the urban type, which is frequently used in operation with hydraulic excavator and is a source of complaints.

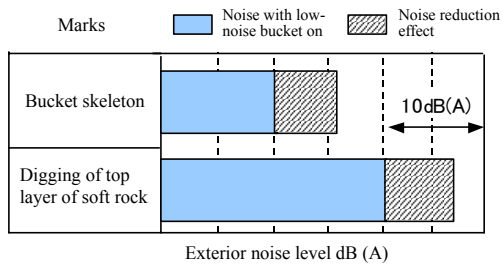


Fig. 13 Effect of low-noise bucket for hydraulic excavator

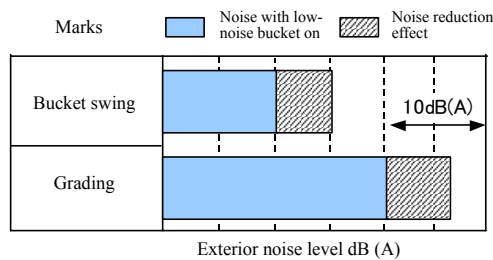


Fig. 14 Effect of low-noise bucket for wheel loader

When mounted with a wheel loader, the low noise bucket accomplished a reduction of 5 dB (A), which was an R&D target under process conditions that generate very large noise, in which the users are strongly interested, such as grading work and bucket wobbling. This led to high user assessment.

5. Conclusion

Low bucket noise in actual work, which is a complaint source of construction machinery, was achieved this time, making great advances in reducing noise in urban civil engineering works during the night and snow plowing that require quietness.

A reduction of 5 dB (A) was accomplished with sounds that are emitted in work when the arm was extended upward and soft rocks were excavated, which is often executed in mountains, although such sounds were not initially anticipated.

During the process of this R&D work, collaboration has been achieved with the Corporate Development Division such as in quality verification and quality building in with the Testing Center of the Field Service Testing Department and cooperation with the Construction Equipment Technical Center and Product Planning Department. The Corporate Development Division was able to merchandise a product in a short time thanks to the support provided by the Product Support Group, Market Development Department, Sales Division, which decides product and market trends and positively undertakes sales

activities, and KAPS.

Using the database of the multi-layer damper, uses of the low noise bucket will be expanded to other models to widely respond to user needs.

6. Acknowledgments

The low noise bucket featuring low cost and high quality has been developed jointly with Maruei Co., Ltd. a manufacturer specialized in buckets and owner of manufacturing and production technology of a high level. The authors thank those at Maruei Co., Ltd. very much for their cooperation.

References:

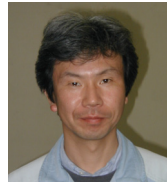
- 1) Kuniaki Nakata, Main Points in Ultra Low Noise Design of Construction Machinery, *Kikai Sekkei*, Vol. 49, No. 8, p. 64 - 69, 2005.
- 2) Kuniaki Nakata, Hydraulic Noise and Reduction Measures, *So-on Seigyo*, Vol. 19, No. 4, p. 15 - 17, 1995.
- 3) Kuniaki Nakata, et al., Research and Development of Hydraulic excavator of Ultra Low Noise Urban Type, *Kensetsu Niyaku Sharyo*, Vol. 22, No. 125, p. 25 - 30, 2000.
- 4) Kuniaki Nakata and Kazuya Imamura, Development of Low Noise Bucket for Wheel Loader, Tr. 2005 Construction Execution and Construction Machinery Symposium, p. 25 - 28, 2005.

Introduction of the writer



Kuniaki Nakada

Entered Komatsu in 1963.
Currently belongs to Innovation Center 1,
Research division



Kazuya Imamura

Entered Komatsu in 1989.
Currently belongs to Innovation Center 1,
Research division



Nitsuo Yabe

Entered Komatsu in 1983.
Currently belongs to Innovation Center 1,
Research division

[A few words from the writer]

The joy comes to those who have engaged in research and development for low noise when the technology that users who have no idea what to do with noise but waiting for the solutions has been researched and merchandised. The reason for naming the product as 3Q (Thank you) bucket and making earnest efforts to merchandise the low noise products, which no other manufacturers in the industry have undertaken, is that we had such enthusiastic will to help them. Honestly, when we heard the actual messages of joy from the users who used it for demonstration, we felt as if all the troubles we had in the research and development were gone in one second.