

## Technical Paper

# Development of ecot3 for Tier 3 Engine (2)

Masayuki Yoshitomi

Hideo Oguri

*The ecot3 engines were developed to meet Tier 3 emission regulations and introduced into the market as Komatsu engine series. Not only the emission regulations but also the low noise and fuel economy are other important propositions, and the ecot3 engine family has been launched as an ecological power source as its name indicates. Medium and Large ecot3 engines were introduced in last Technology Report. The background of the development and technical features are described below.*

**Key Words:** Diesel engine, environmental friendliness, Tier 3, electronic control, common rail system

## 1. Introduction

The overview and technical features of the Medium and Large ecot3 engines were introduced in the previous Technology Report No. 157. The features of the small ecot3 engine covering the output range of 75kW to 225kW are described.

This paper describes the SAA6(4)D107 and SAA6D114 engines that meet the Tier3 emission regulations. However, the technologies implemented in them differ slightly from those incorporated in medium and large engines. One prominent difference is that Tier3 emission regulations are met without the use of cooled EGR technology, which represented a considerable challenge. However, compliance with the Tier3 emission regulation while maintaining the previous fuel consumption level was enabled via the use of an electronically controlled high pressure common rail and through the optimization of combustion technology.

From mid-2005 onwards, mass production of these engines started, initially for the PC200-8 and PC300-7E0, and the products have been critically acclaimed by the market. The SAA4(6)D107 and SAA6D114 engines that meet the Tier3 emission regulation are described below.

## 2. Trends of Emission Regulations for Construction Machinery Engines

The so-called Tier3 regulations, mainly in force in North America and Europe, as well as on/off road Tier-3 emission regulations for specified construction machinery in Japan comprise emission regulations governing diesel engines for construction machinery.

The starting time for the enforcement and regulatory values themselves differ slightly for the output range of 56 to 225kW, covering the SAA4(6)D107 and SAA6D114 engines, and based on the actual output figure. Regulation on engines in output ranges exceeding 130kW was enforced from 2006, whereas from 2007, regulation has been successively enforced on engines of less than 130kW in output, in accordance with the output range.

Compared with the Tier2 regulation, the Tier3 regulation sets the same regulatory value for particulate matter (PM) while that for nitrogen oxide (NOx) is set 40% lower. The focus of the development was, therefore, compliance with the stringent NOx regulatory value without causing the fuel economy or PM emission level to deteriorate.

## 3. Small Engine Series of ecot3 (ecology & economy - technology3)

### 3.1 Overview

Komatsu is currently developing, manufacturing and selling industrial diesel engines ranging from 3.3L to 78L. As mentioned earlier, new emission regulations have been and will be enforced in 2006 and 2007 in Japan, the United States and Europe. Among the family engines meeting these regulations and with capacities ranging from 3.3L to 23.2L and an output of less than 560kW, the medium to small-sized ecot3 engines with displacement capacities of 4.5, 6.7 and 8.3L respectively are described.

**Figure 1** shows the displacements and outputs of the ecot3 engine series. Among the engines in this series, the displacements of the 4.5L SAA4(6)D107 and 6.7L SAA6D107

engines have been increased about 14% compared with the existing 3.9 and 5.9L by increasing the bore and stroke based on the previous 102mm bore engine, allowing the engines to be run with a leeway. By installing the new engines in some of the vehicles that previously installed the 114 Engine, the cost of vehicles has been reduced. The increase in displacement has been achieved by changing the liner part of the cylinder block to a Siamese structure while maintaining the same cylinder pitch as in the 102 Engine. Consequently, the external dimensions of the cylinder block are as before, forestalling any impact on the machine body at the engine replacement from the 102 engine.

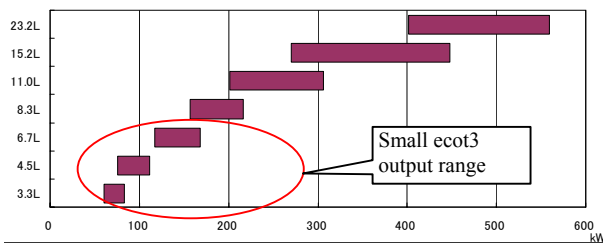

Fig. 1 Komatsu ecot3 engine series

Figure 2 summarizes the trends of the technologies incorporated in the engines to meet the Tier1, Tier2 and now Tier3 emission regulations.

The combustion temperature inside the cylinders must be lowered to curb the oxidation of nitrogen and thus reduce the generation of nitrogen oxide (NOx). As one means of achieving this, changes have been made from supercharging engines (S) to engines with a water-cooled aftercooler (SA) and those with an air-to-air air-cooled aftercooler (SAA) to lower the charge temperature before combustion. All the engines in the ecot3 SAA4(6)D107 and SAA6D114 engine series are of the air-cooled aftercooler specification.

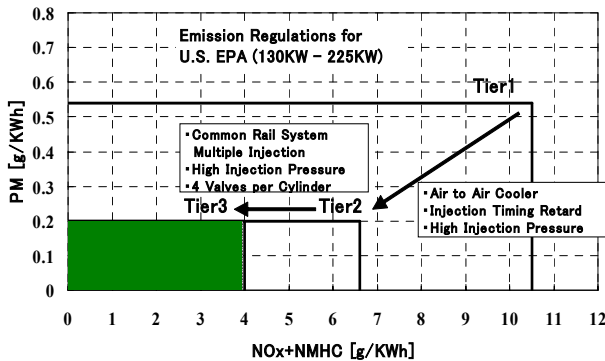

Fig. 2 Overview of technologies incorporated to reduce emissions

The 40% reduction in nitrogen oxide required by the Tier3 emission regulation as part of Tier3 regulation proposals was accomplished by reviewing the combustion concept, optimizing injection time and incorporating combustion improvement technology through multiple-mode injection. The reduction of particulate matter (PM) was accomplished by the use of the electronically controlled common rail high

pressure injection system, which implemented new improvements such as short injection time, micro fuel atomization via high pressure injection and improved combustion during the final stage of combustion by the multi-stage injection of fuel.

### 3.2 Aims for the development of ecot3 engine series

- 1) Compliance with all Tier3 emission regulations of Japan, the United States and Europe
- 2) Equivalent or superior engine performance (in terms of output and fuel economy) to existing machines
- 3) Reduced noise to meet EU noise regulations and the domestic super low noise regulations concerning construction machinery
- 4) Reliability and durability as industrial engines for construction and other forms of machinery.
- 5) Multi-purpose universality of Tier2 engines to endure use in diverse global environments.

The principal specification list of the small ecot3 engines is presented in Fig. 3, where an electronically controlled high pressure common rail system is adopted in place of the mechanically controlled fuel injection pump used up to the Tier2 regulation era, in order to meet the development aims. The number of intake and exhaust valves per cylinder has been increased from the previous two valves per cylinder to four, to boost the intake air volume. The injector is placed in the center of each cylinder to ensure uniform fuel atomization in the combustion chambers and achieve the targeted emission performance.

Engine Model	Tier2			Tier3		
	SAA4D102	SAA6D102	SAA6D114	SAA4D107	SAA6D107	SAA6D114
Number of Cylinder	4	6	6	4	6	6
Bore × Stroke (mm)	102 × 120	102 × 120	114 × 135	107 × 124	107 × 124	114 × 135
Displacement (ltr)	3.92	5.88	8.27	4.46	6.69	8.27
Aspiration	Turbocharged Air-Cooled Aftercooler			Turbocharged Air-Cooled Aftercooler		
Fuel System	Conventional Mechanical Pump			Common Rail System		
Engine Control	Mechanical			Electronic		
Valve per Cylinder	2 valves per cylinder			4 valves per cylinder		

Fig. 3 Principal specification of the small ecot3 engine series and the technologies incorporated in the series

Figure 4 shows a full view of the SAA6D107 engine installed on the PC200-8, the flagship Komatsu vehicle.

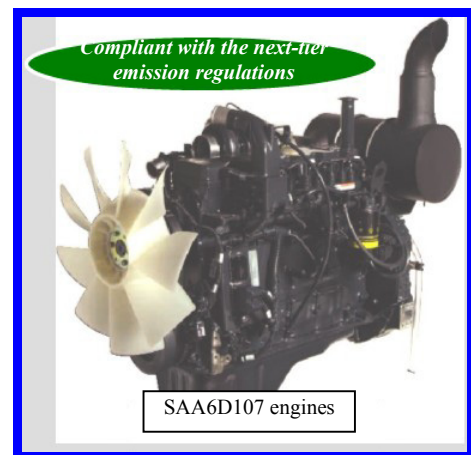

Fig. 4 ecot3 series SAA6D107E-1 engine

## 4. ecot3 Engine Technology

Using a newly developed engine that meets the Tier3 emission regulations, the ecot3 technology meets the most recent global gas emission regulations, yet guarantees engine performance (in terms of output and fuel consumption), reliability and durability equivalent or superior to those of existing models and drastically reducing noise compared with the conventional engines, as reported below.

### 4.1 Electronic control system

As mentioned earlier, the new ecot3 engine series comes with an electronically controlled common rail injection system and uses a common electronic control system for the full range of engines, from large to small. To perfect this common electronic control system, quality verification was performed for a total of 100,000 hours to ensure durability and reliability that would fully meet customer expectations.

In the area of functions, the system controls the engine, including the common rail injection system, as well as data interchanges with the VCM (vehicular computer) through high-speed CAN communications. The system also provides interfaces that interact with the KOMTRAX system.

### 4.2 Heavy duty common rail injection system

All the engine families of the **ecot3** engine series come with an electronically controlled common rail injection system. The fuel injection system for small models is a system manufactured by Bosch, which has proven to be globally viable. The fuel supply pump of the SAA6D114 engine in the system is manufactured by Cummings.

The common rail injection system features not only high-pressure injection, but also a high degree of freedom in terms of injection time and multi-mode injection, reputedly having the best potential of all the various injection systems.

Komatsu was the pioneer in mounting a common rail fuel injection system in high-speed diesel engines for its medium and large construction machines already in conformance with Tier2 emission regulation. Komatsu also established engine performance at the same time through experience, achieving both low emissions and high performance. **Figure 5** shows the schematic diagram of the new heavy duty common rail system adopted in the Komatsu engines.

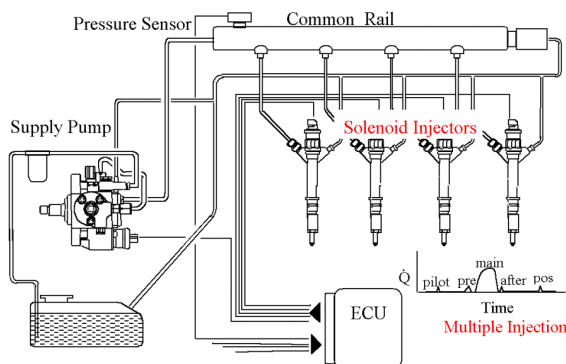

**Fig. 5** Common rail fuel injection system

**Figure 6** shows a full view of the fuel injector. The solenoid in the upper part of the injector opens and closes a 2-way valve on the push rod instantaneously and varies the injection by changing the balance of fuel pressure, to facilitate multi-mode injection. The 107 and 114 Engines use the same injector manufactured by Bosch, which has been proven fully viable in terms of quality as a fuel injection part for use in construction machines, and with a stringent operating environment, after verifying the resistance to dust and other parameters.



**Fig. 6** Full view of injector

**Figure 7** is a schematic diagram of multi-mode injection used in small ecot3.

- (1) The pilot injection curbs rapid heat generation via the main injection, thereby suppressing NO<sub>x</sub> generation. The pilot injection is also effective in reducing combustion noise.
- (2) In regions of high output and high speed, post injection is added to accelerate the oxidation of soot in the final stage of combustion, reducing the generation of smoke and PM.

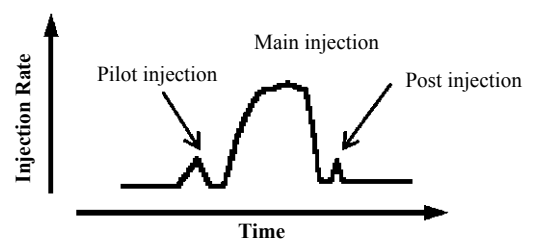

**Fig. 7** Schematic diagram of multi-mode injection

**Figure 8** shows a full view model of a fuel supply pump for the SAA4(6)D107 engines manufactured by Bosch. Many such pumps have been produced for truck engines in bulk production. The pump is lightweight and compact, due to the fuel lubrication and needs no pipe for lubricating oil. The exterior design, meanwhile, is simple and suitable for small engines. This pump is set to 1.33 times the engine rotation speed and includes three plungers that feed the pressurized fuel. This common rail system can generate up to 1600bar in maximum injection pressure.

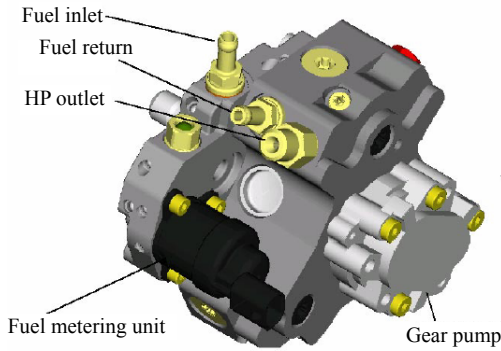

Fig. 8 Fuel supply pump for the 107 Engine

On the other hand, the fuel supply pump for the SAA6D114 engine is of a tandem in-line plunger type, oil-lubricated, and places more emphasis on reliability. A full view of it is shown in Fig. 9.

All the pumps have been perfected by subjecting them to quality verification against various test codes required for use in construction machinery, based on experience achieved in meeting the Tier2 emission regulations. Modifications have been made to every detail and a system well deserving of the title heavy duty specification has been completed.

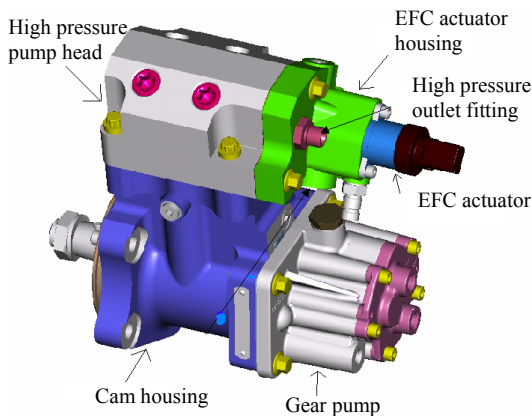

Fig. 9 Fuel supply pump for 114 Engine (Full view)

### 4.3 ecot3 combustion system

An emphasis was placed especially on the development of a combustion system in new engines that meets the Tier3 emission regulation. The cooled EGR adopted in medium to large engines is effective in reducing NOx without deteriorating the fuel consumption rate. However, the increased cost of the cooled EGR, valve and other components is a negative factor, especially for small engines. A new combustion system was adopted to achieve high performance and meet emission regulations through enhanced injection performance via the electronically controlled common rail and by developing a new combustion technology, to simultaneously reduce NOx and PM without using a cooled EGR.

The basic concept of the new combustion system is illustrated in Fig. 10. The point in the development work was to find a way to reduce NOx emissions without using a cooled

EGR. The development was undertaken based on the following two points as the main concepts:

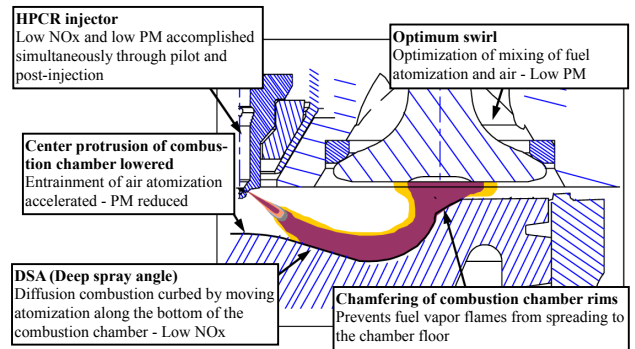

Fig. 10 Concepts of Ecot3 combustion

- (1) The relationship between the shape of the piston combustion chamber and fuel spraying is optimized to curb the generation of thermal NOx increased by high temperature, by curbing, in turn, the rapid combustion during the initial stage of fuel injection.
- (2) To design a combustion chamber so that active combustion takes place in the final stage of combustion to accelerate the oxidation of soot, and curb emissions of PM and smoke.

To implement the foregoing combustion concepts, simulation calculations by KIVA and bench performance tests were repeated to optimize the layout between the shape of the piston combustion chamber and the diameter of the fuel spraying hole, and satisfactory emission and general performance was achieved.

Figure 11 shows the results of the analysis of the KIVA combustion simulation.

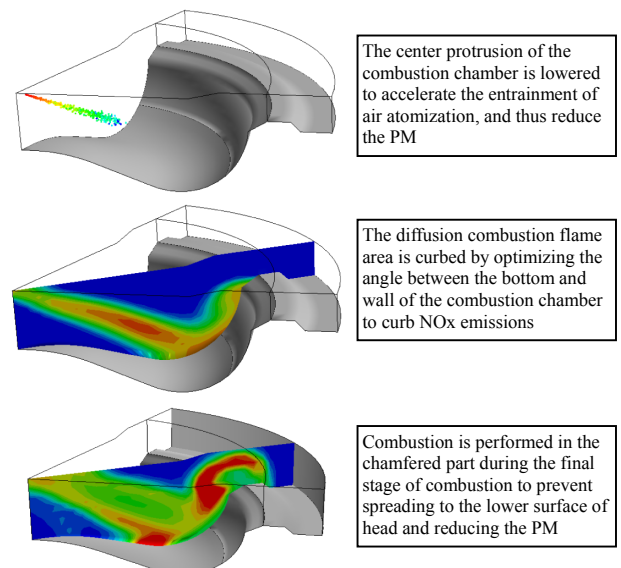

Fig. 11 Combustion simulation by KIVA

As shown by the heat release patterns in a cylinder plotted in Fig. 12, heat is generated slowly during the initial stage of combustion, thereby contributing to a reduction in thermal NOx during the initial stage. The heat release rate lowers and the oxidation of soot progresses swiftly during the final stage of combustion, thereby reducing PM emissions.

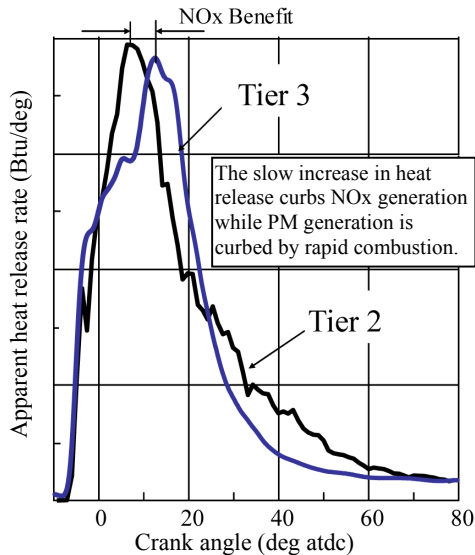

Fig. 12 Result of combustion simulation of heat release patterns

4.4 Emission and fuel consumption

Optimization of contradicting proposals for emission reduction and the maintenance of low fuel consumption was achieved by effectively utilizing multi-mode injections shown in Fig. 7 as the basic concept of the injection system, as opposed to the basic concepts of the combustion system. As shown in Fig. 13, NOx and PM levels in the achievement performance of the Tier3 SAA6D107E-1 engine are sufficiently high in relation to the Tier3 emission regulation levels, while accomplishing an equal fuel consumption rate in relation to Tier2 engines.

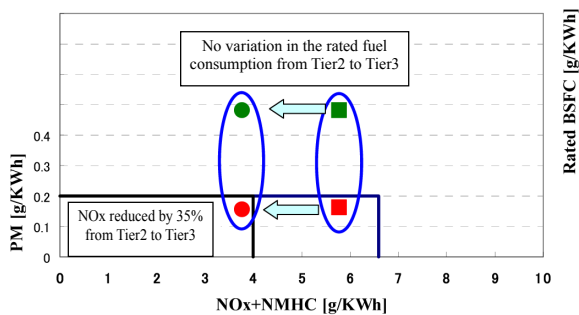

Fig. 13 Achievement of emission and fuel consumption

4.5 Noise

Beginning 2006, in Europe, the EU dynamic Tier2 noise regulation has been enforced with construction machinery. The PC200-8 has cited the accomplishment of a super low noise level of Japan as a standard specification. With this in mind, quietness of the engine was one of the important targets during the development of the engine series.

The noise of the engine was lowered by using pilot injection to reduce the combustion noise via the use of the electronically controlled common rail injection system. The 107 Engine series reduced noise (1) by lessening the gear noise through the provision of a gear to the node of the torsional vibration of the crank shaft, as a rear gear train structure, and (2) through a reduction of radiation sound, caused by vibration of the cylinder block by reinforcing the stiffener of the cylinder block skirt.

As a method to reduce noise, the sources generating most noise had to be identified and a beam forming method was used in this development work to assess the sound sources. An example of sound source searching using the beam forming method is shown in Fig. 14.

Compared with the conventional engine models, noise could be reduced significantly by changing the engine structure and identifying and improving sound sources.

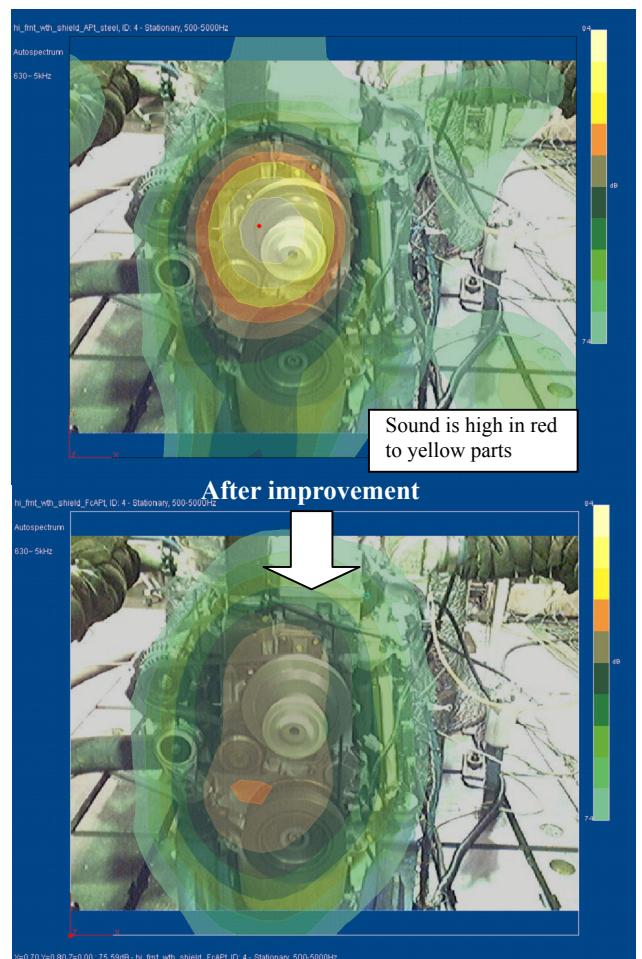
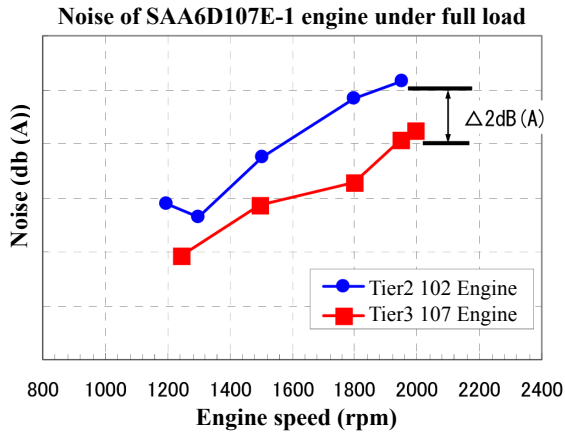

Fig. 14 Sound source search by beam forming and improvement made

**Figure 15** compares engine noise with both the new SAA6D107E-1 engine and existing SAA6D102 engine under full load. The new engine was subsequently found to reduce noise by 2dB (A) on average in all regions, both under load and no load conditions.



**Fig. 15** Effect of engine noise reduction

Under a full load, combustion noise was a dominant factor in engine noise and slow initial combustion by pilot injection curbed a radical increase in pressure inside the cylinders, to reduce noise. On the other hand, the gear meshing sound and mechanical noise caused by vibration of the cylinder block were found to generate most noise under conditions of no load. The rear gear train structure and reinforced stiffener in the lower part of the cylinder block also contributed to reducing mechanical noise.

In both the 107 and 114 Engines, noise is also reduced also by lowering the engine speed under a light load by isochronous control tuned to vehicle requirements.

**4.6 Engine startability**

The electronically controlled common rail injection system enabled optimum control of fuel injection characteristics during engine start-up, which could not be controlled by the mechanically controlled fuel injection systems up to Tier2, achieving both good startability at a low temperature and a drastic reduction in emissions of black smoke at a normal temperature.

Fuels of a low cetane number are used in North America and some other regions and a major problem in these regions in the past with mechanically controlled fuel injection pumps, which had many limitations in complying with Tier1 and Tier2 regulations, was the control of white smoke being emitted when the engine was started at a low temperature. The electronically controlled common rail injection system has drastically reduced emissions of white smoke during engine start-up at low temperatures, even with fuels of a low cetane number. The engine has indeed become eco friendly under various environmental conditions.

**4.7 Air-to-air air intake cooling system**

Another important element of emission technologies for engines of construction machinery is the technology related to the air-cooled aftercooler that has been adopted in dealing

with the Tier2 regulation. This technology aims to increase the density of air suctioned into the engine cylinders and lower the temperature of the intake air. The system cools the temperature of air supercharged by the turbo charger down to a necessary temperature by a heat exchanger (air-to-air) with outer air. This system lowers the combustion temperature and reduces NOx emissions.

**Figure 16** shows the relationship between the intake air temperature and NOx emissions. By lowering the intake air temperature by 5°C, NOx emissions at a rating point can be reduced by about 7%. The small ecot3 engine feeds air of a larger quantity than the Tier2 specification into the engine, to reduce emissions, and this air-cooled aftercooler plays a very important role.

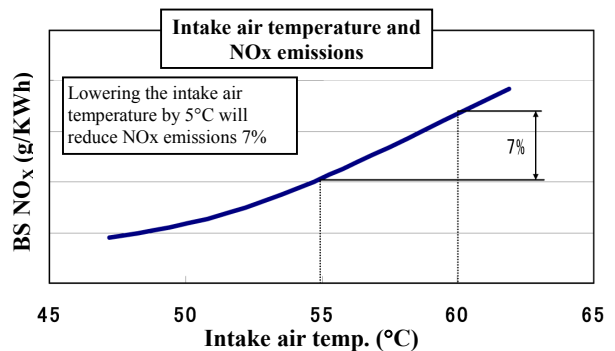

**Fig. 16** Intake air temperature and NOx emissions

The cooling losses of the new SAA6D107 engine and a Komatsu Tier2 engine are compared in **Fig. 17**. A combustion efficiency equivalent to that of a Tier2 engine was accomplished and heat losses to cooling water could be prevented. On the other hand, the intake air quantity was increased to meet the Tier3 regulations and the temperature at the outlet of the air-cooled aftercooler was set 5°C lower than the conventional Tier2 specification. The net result was that cooling losses of the air-cooled aftercooler increased by 17%, but the heat loss increase for the entire engine was 4%, meaning that significant increases in the capacities of cooling components, such as the radiator and air-cooled aftercooler, could be curbed.

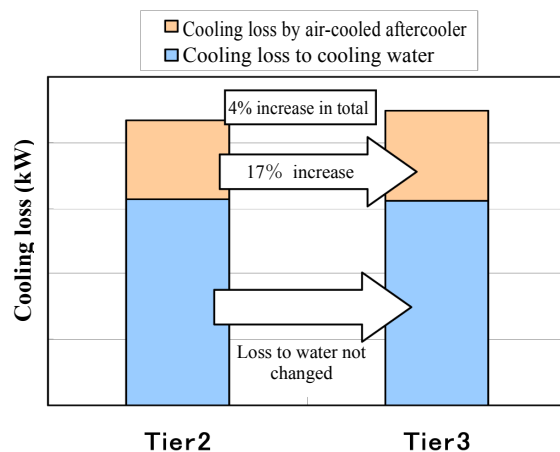

**Fig. 17** Comparison of cooling losses of Tier2 and ecot3

## 5. Reliability and Durability

Throughout the development process of the new ecot3 engine series, all the quality verification codes of Komatsu for industrial engines that had been set were met. New evaluation test codes were additionally developed and added to evaluate the new injection system and verification tests to adequately ensure reliability and durability of the new technologies were conducted. Flawless and fine control under a variety of environmental conditions, such as operation in the highlands and under auxiliary operation materials, including low-grade fuel and oil, was of concern especially due to the adoption of the electronically controlled common rail injection system. Sufficient tests were conducted to verify quality under these severe conditions. In parallel with the adoption of the common rail injection system, a high-efficiency fuel filtration system was developed to protect the fuel injection system in a dusty environment for use in global markets.

Almost all the components of the 107 Engine with an increase in displacement were newly designed, including the engine structure, power cylinder, valve mechanism, lubrication system and injection system. Their durability and reliability were verified in durability and abuse bench tests, as well as in field tests in vehicles, totaling 10,000 hours in duration. Problems encountered in these tests were correctly addressed and regular production commenced after all the new parts were verified to pass the quality target.

## 6. Conclusion

The features and emission reduction technologies of the new small “ecot3” diesel engine for construction machinery meeting the Tier3 emission regulation are described.

Conventional technologies for fuel injection were found to be unable to meet the Tier3 emission regulations and a new common rail system was adopted to do so. As additional technology to meet the next Tier4 emission regulation, post-processing of exhaust gases will be mandatory. In addition to exhaust gas regulations, environmental considerations are demanded by society, including noise regulation and the recycling of parts. The engineers engaged in engine development must build and introduce engines to the market in a timely fashion to meet such social needs.

The share of passenger cars powered by a diesel engine is increasing in Europe because of their high fuel economy. Once emissions of diesel particulate, which is a weakness of diesel engines, are reduced, high-efficiency diesel engines will naturally survive as engines that are environmentally friendly due to low CO<sub>2</sub> emission amount.

Research and development of hybrid and fuel cell technologies is also conducted for construction machinery, although these technologies are not yet viable to replace diesel engines. Construction machinery manufacturers have already started moves toward the next phase to establish technologies to meet the Tier4 regulation using diesel engines. It is felt that challenges must constantly be made to innovate technology to develop Tier4 engines that will reduce emission gases and be friendly to customers and the environment.

About one year has passed after the ecot3 engine made its market debut and the evaluation results of the market on the engine will be fed back. Our task will be to absorb such market information to refine and mature the engine to further improve it and to pass on the information gained during such process to develop a Tier4 engine.

### References:

ENGINE TECHNOLOGY April 2006  
State-of-the-art technology of “Komatsu ecot3 Engine”  
“Development of Tier Engine ecot3,” Komatsu Technical Report No. 157

### Introduction of the writers



**Masayuki Yoshitomi**

Entered Komatsu in 1981.  
Currently assigned to the Product Engineering Group, Industrial Power Alliance, Ltd.



**Hideo Oguri**

Entered Komatsu in 1983.  
Currently assigned to the Product Engineering Group, Industrial Power Alliance, Ltd.

### [A few words from the writers]

One year has already passed since the 107 and 114 Engines meeting Tier3 were introduced to the market. Their market introduction has been smooth, without major problems, which is a reward for the development effort and previous hard work. Hardly resting, even for a moment, the new task of developing a Tier4 engine has already started and the Tier3 engine is now a thing of the past for the IPA. The challenge for IPA to engage in the mass production of Tier4 engines is now entering its critical phase.