

Introduction of Products

Compact Excavator PC30UU/30UUC-6

Tadashi Shintani

Yoshiteru Kubo

Compact excavators, models PC30UU/30UUC-6, which are compliant with Tier 4 emission regulations, have been developed under the concept of “environment”, “safety”, and “ICT (information and communications technology)”, and launched in the market.

This report introduces the main features of these models.

Key Words: *Compact excavator, Emissions regulations, KOMTRAX, UU-6, Super small swing, Tilt-up, Automatic interference avoidance*

1. Introduction

The compact excavator PC30UU featuring super small swing in the 3 ton class was model-changed in 2008 in compliance with the 2006 regulations for emissions from non-road special motor vehicles, but has not been fully model-changed for more than 10 years.

To comply with the 2011 regulations for emissions from non-road special motor vehicles, we changed the engine output classification from the classification covered by the off-road act to the classification of the Third Regulation of Exhaust Gas of the Japanese Ministry of Land, Infrastructure, Transport and Tourism (JMLIT).

As well as complying with this regulation, we have developed a model changed machine (PC30UU-6) incorporating the improvements in product competitiveness and launched it in the market.

The mass has increased relative to the conventional PC30UU by adopting the operator’s seat protection structure (TOPS) and the tilt-up mechanism. Thus, in consideration of the vehicle transportability, PC30UUC-6, which can be less than 3 tons even with the arm crane specification the demand for which is rising recently, has also been developed by reducing the undercarriage mass; we also report this herein.



Fig. 1 Appearance of PC30UU-6
(photo in the pamphlet)

Table 1 Machine mass

	Machine model	
Machine mass (kg)	PC30UU-6	PC30UUC-6
Standard specifications (canopy and rubber shoe)	2990	2920
Arm crane specifications (canopy and rubber shoe)	3030	2960

2. Aims of Development

With the “quality and reliability” of Komatsu as the base, we made the machine meet the environmental regulations and also incorporated the safety pursued and ICT technology into the machine so that it can be significantly improved in the maintainability and workability.

This section outlines the machine and lists its features.

- (1) Environment
 - Compliance with the new emissions regulations
 - Compliance with the JMLIT Ultra low noise regulations
- (2) Safety
 - TOPS compliant canopy/cab
 - Lock lever automatic locking function
 - Seat belt warning function
 - Secondary engine stop switch
 - Hydraulic lock for all levers provided with (PPC for all systems)
- (3) ICT
 - Equipped with 3.5-inch color liquid crystal multifunction monitor
 - Expansion of information collected by KOMTRAX
 - ID key
 - Operator identification and authentication
- (4) Added functions
 - Floor tilt-up structure
 - Work equipment automatic avoidance function
 - E mode and auto-deceleration

3.1 Environmental

3.1.1 Compliance with the emissions regulations

To suppress the engine structure change and cost increase by adding an exhaust gas aftertreatment system, PC30UU-6 was designed to conform to the regulations, by changing the engine output classification from the classification covered by the off-road act to the classification covered by the Third Regulation of Exhaust Gas of JMLIT. (Table 2)

Table 2 Trend in exhaust gas regulation

Output range	2012	2013	2014	2015	2016	2017	2018	2019	2020
8 ~ 19kW	Construction equipment with measures for the JMLIT Third Regulation of Exhaust Gas.								
19 ~ 37kW	Regulations of the off-road act 2006		Regulations of the off-road act 2011 Period of probation → (*15/8)			Regulations of the off-road act 2014 → Period of probation (*17/9)			

PC30UU-6(18.9kW)

PC30UU-5(22.0kW)

Although the gross engine output was changed from 22.0 to 18.9 kW, a work capability equivalent to the conventional machine has been realized by controlling the hydraulic system optimally along with the operating status by means of the Komatsu’s unique electronic control (Fig. 2). (Table 3)

Table 3 Work amount

Item		Index	PC30UU-6	PC30UU-5
Trench digging 45 deg dumping	Work rate	%	104	100
	Cycle time	%	97	100
Loading the dump truck (swinging by 90 deg)	Work rate	%	102	100
	Cycle time	%	98	100

3. Selling Points and Means for Achieving the Goal

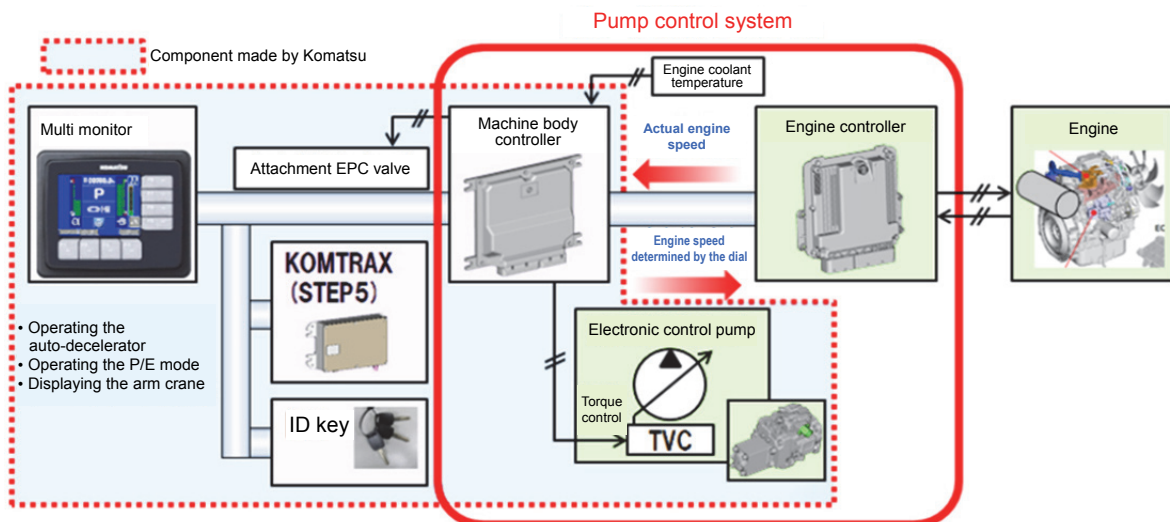

Fig. 2 Control system (from company data)

3.1.2 Compliance with ultra low noise regulations

By readjusting the hydraulic components, systems, and engine rated speed, the noise from the engine was significantly reduced, realizing a more comfortable operator's seat area than the conventional machine.

The machine also cleared the ultra low noise regulations as required by the JMLIT.

3.2 Safety

3.2.1 TOPS canopy and cab

To protect the operator from tipping over and falling objects, this machine is standard-equipped with a canopy conforming to TOPS (ISO12117 (JIS A 8921), **Fig. 3**) and an automatic retractable seat belt, with the operational head guard conforming to the OPG top guard level 1 (ISO10262 (JIS A 8922)). The optional cab also conforms to both standards.



Fig. 3 TOPS canopy
(from company data)

3.2.2 Lock Lever Automatic Locking Function

This machine is provided with a new function that allows the engine to start only when the lock lever is at the lock position. Further, this function displays the warning on the monitor without moving the work equipment even when the lock lever is unlocked with the work equipment lever or travel lever not positioned at the neutral position. (**Fig. 4**)

This prevents accidents that would occur due to unpredictable machine operation or swinging of the work equipment caused by erroneous human operation.

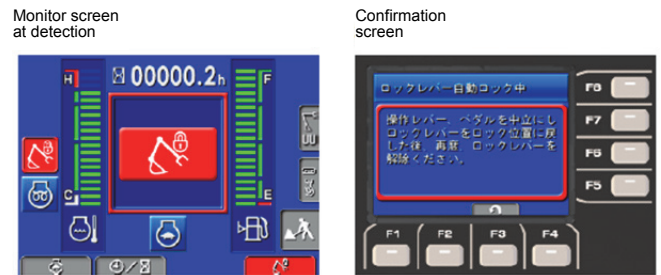

Fig. 4 Lock lever automatic locking function
(from company data)

3.2.3 Seat belt warning

This machine is provided with a new function that warns the operator of forgetting to tighten the seat belt by lighting up the icon on the monitor screen. (**Fig. 5**)

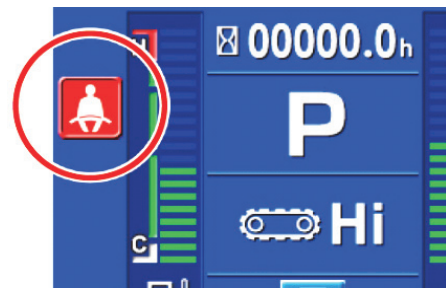

Fig. 5 Seat belt warning alarm
(from company data)

3.2.4 Secondary engine stop switch

At the bottom left of the operator's seat, a switch is provided to stop the engine when the machine causes an abnormality and cannot be stopped by turning off the ignition switch. (**Fig. 6**)

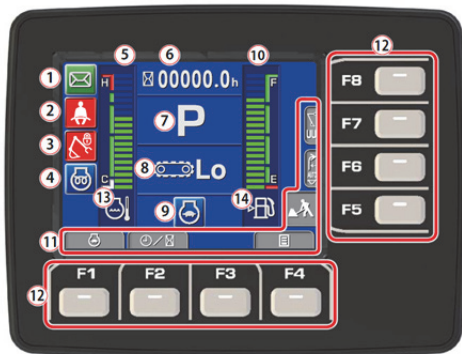

Fig. 6 Secondary engine stop switch
(from company data)

3.3 ICT

3.3.1 3.5-Inch color liquid crystal multifunction monitor (standard equipment)

For the monitor screen, a high definition liquid crystal panel with high resolution and excellent visibility was newly adopted so that the visibility can be significantly improved. The monitor not only displays various cautions and vehicle information comprehensively, but also provides user support functions such as displaying operation records, machine settings, and maintenance information. With this monitor, a meticulous support system has been realized; for example, it allows the operator to perform one-touch operation to switch the view from the multi monitor basic screen to each individual function screen. (Fig. 7)



- indicator**
- ① User message indication
 - ② Seat belt non-tightening warning lamp
 - ③ Lock lever indicator lamp / interference avoidance
 - ④ Preheating indicator lamp / height limit
 - ⑤ Engine water temperature gauge
 - ⑥ Service meter / clock
 - ⑦ Work mode indication
 - ⑧ Travel speed indication
 - ⑨ Auto-decelerator indicator lamp
 - ⑩ Fuel gauge
 - ⑪ Guidance icon
 - ⑫ Function switch
 - ⑬ Engine water temperature warning lamp
 - ⑭ Fuel residual quantity warning lamp

Fig. 7 Multi monitor basic screen (from company data)

3.3.2 Expansion of information collected by KOMTRAX

In addition to conventional position information and service meter time information, the monitor can also show the working conditions including the operating time, work mode, and load frequency and enables the manager as well as the operator to capture the machine status in detail.

Main items of the information

- Actual operating time
- Work mode time (E or P mode)
- Traveling time
- Travel mode time (Hi, Lo)
- Load frequency
- Error information
- Replacement information about maintenance items

3.3.3 Reducing theft risk by adopting ID keys

ID ignition keys with a built-in IC chip are offered to the user as standard equipment. The engine was designed to start only with the ID key preregistered on the machine.

In addition, by the individual ID embedded in the ID key, it is possible to capture the information about the operating time zone, operating time, idling time, operation mode setting time, fuel consumption, etc. for each operator (ID key). Accordingly, the manager can capture the habit of driving for each operator as well as the vehicle condition more easily and advise each operator adequately. (Fig. 8)

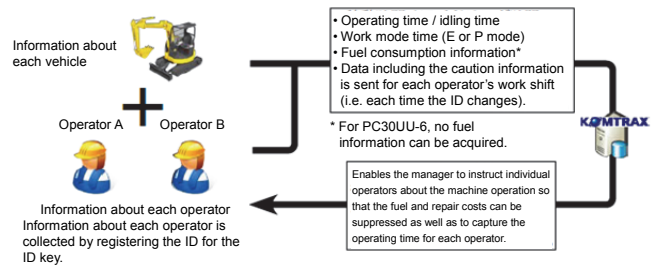

Fig. 8 Operator identification function (from company data)

3.4 Added functions

3.4.1 Maintainability

1) Floor tilt-up structure

The floor tilt-up mechanism was adopted. While this is a super small swing machine with a narrow space, its maintainability has been significantly improved so that eyes can reach every corner of the vehicle during full-scale maintenance.

In addition, the daily check points are accessible by opening only the lateral opening engine hood and large side cover. (Fig. 9)



Fig. 9 Floor tilt-up mechanism and full opening cover
(from company data)

2) Battery ground quick connector

This machine is equipped with a battery ground quick connector that allows to disconnect the battery without using tools during maintenance of the electric circuit. (**Fig. 10**)

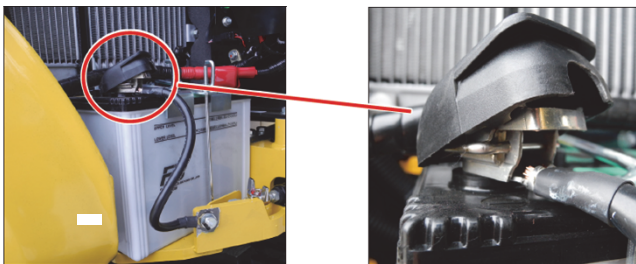

Fig. 10 Battery ground quick connector
(from company data)

3.4.2 Workability

1) Automatic interference avoidance system

When the bucket approaches the driver's seat and enters the deceleration zone, the speed of the work equipment automatically decreases like the conventional interference prevention system (**Fig. 12**). When the bucket further comes to the interference avoiding surface, it avoids the operator's seat by moving along the interference avoiding surface without stopping during the boom raising operation. (**Fig. 11**)

Accordingly, the operator can continue work without stopping the work equipment even in a narrow place or the like.

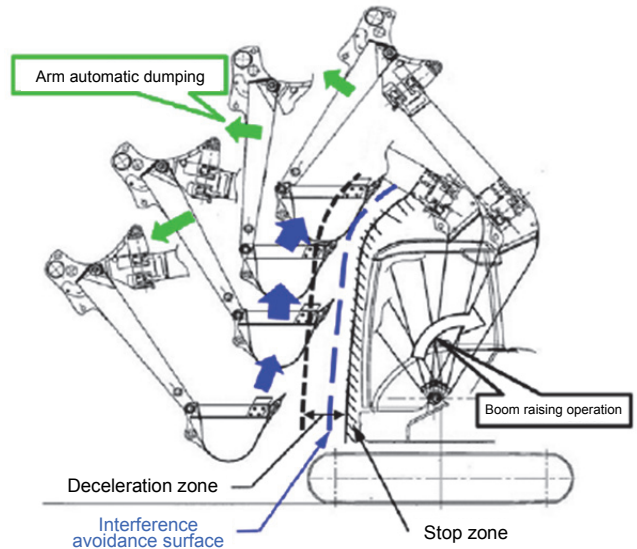

Fig. 11 Automatic interference avoidance system
(from company data)

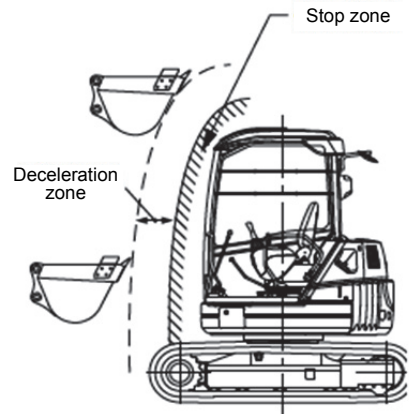

Fig. 12 Interference prevention system
(from company data)

2) Depth measurement system

During excavation work, the depth from the ground (i.e. absolute depth) and that from arbitrarily set reference (i.e. relative depth) can be monitored so that a worker other than the operator do not need to measure the digging depth each time. (Depth indication mode)

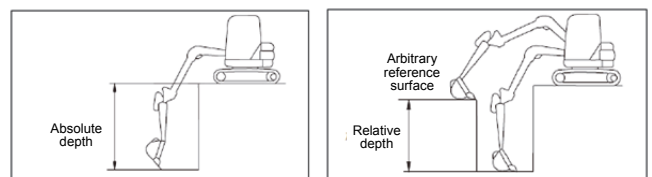

Fig. 13 Depth measurement system
(from company data)

3.4.3 Reduced fuel consumption

The PC30UU-6 has achieved 5% reduction in fuel consumption relative to the conventional machine in terms of fuel consumption during the average work pattern. In addition, in terms of the JCMAS fuel consumption standards, it completed the 2020 fuel consumption standard achievement rate of 100% or more (☆☆☆) defined by the JMLIT.

In addition, this machine is equipped with functions such as the auto-deceleration that automatically lowers the engine speed to suppress extra fuel consumption in the light work E mode or idling, and the auto idle stop function that automatically stops the engine when idling continues for the preset time.

Table 4 Fuel consumption

Item	Model	Komatsu PC30UU-6		Komatsu PC30UU-5		
		P	E	P	E	
During 90 deg swing, digging, and loading work	Mode	—				
	Work rate	%	102	101	100	—
	Fuel consumption	%	100	84	100	—
	Work amount per unit of fuel consumption unit	%	102	120	100	—
Fuel consumption of average work pattern	%	95		100		

3.4.4 Features of PC30UUC-6

The undercarriage was weight-reduced so that the total weight of PC30UUC-6 can be less than 3 tons in the arm crane specification, resulting in a reduction in machine mass by 70 kg relative to PC30UU-6. (Fig. 14)

Although the center distance of tumblers has been shortened by readjusting the roller position, this machine has achieved the stability performance equivalent to that of the conventional machine.

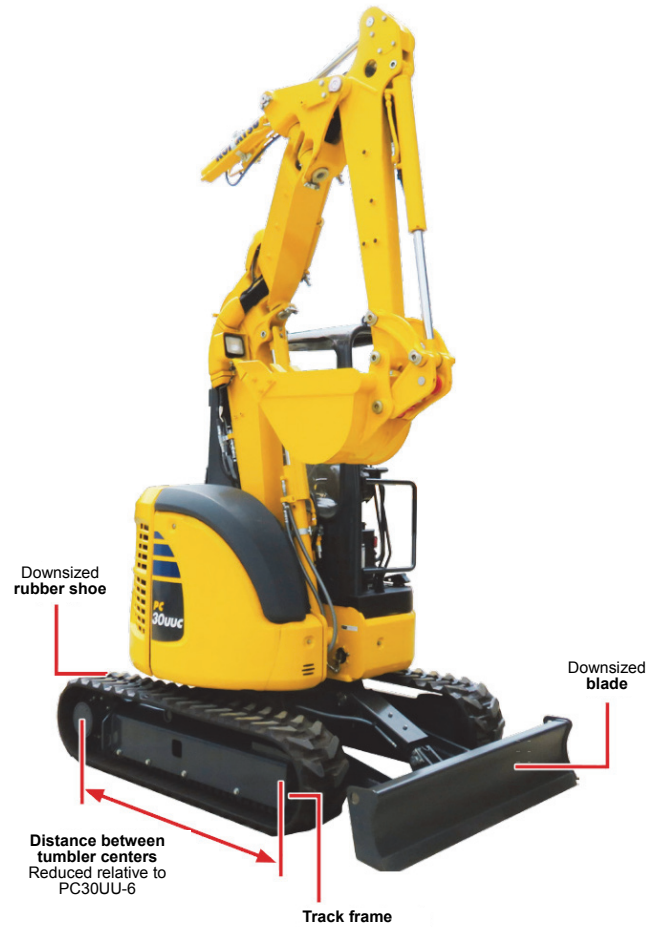

Fig. 14 Appearance of PC30UUC-6 (from company data)

Table 5 Principal dimensions of undercarriage

Item	Model	Komatsu PC30UUC-6	Komatsu PC30UU-6	
Distance between tumbler centers	A mm	1485	1650	
Blade	Width	mm	←	
	Height	B mm	325	
	From center of swing to blade tip touching the ground	C mm	1400	
	Working ranges Blade lifting height	Above the ground level	D mm	330
		Under the ground level	E mm	275

4. Conclusion

Following the PC58UU-6 machine, developed in advance as one of the Komatsu's super small swing compact excavators, we succeeded to develop the PC30UU-6 in a short time while improving the product competitiveness by incorporating the functions demanded in the market into the machine as well as clearing the regulations for emissions from non-road special motor vehicles. We will make effort to introduce better products to the market along with the UU series products that will be developed continuously.

Introduction of the writers

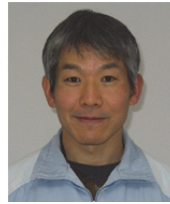

Tadashi Shintani

Joined Komatsu Ltd. in 1998.
Construction Machinery Development
Center 1, Development Division



Yoshiteru Kubo

Joined Komatsu Ltd. in 1995.
Utility Development Center, Development
Division

[A few words from writers]

We accomplished the model change of PC30UU that was demanded over years although there were various difficulties due to a narrow space.

We are proud that we succeeded in developing products that satisfy our customers by overcoming all of the above difficulties by constantly repeating discussions brightly and lively with positive motivation.

We appreciate everyone belonging to the departments involved in the development, mass production, and market introduction of this machine. While keeping the originality and ingenuity in mind, we will continue to deliver to the world, products that our customers will be surprised as "Truly Komatsu!".